

Counting Scales

HC-i Series



A&D ...Clearly a Better Value
A&D Company, Limited
<http://www.aandd.jp>

Simple and Easy Operation with High Performance Counting Function!

With the HC-i series and its accessories, you can easily build an inexpensive inventory control system. The HC-i series is cost effective and will improve reliability by eliminating errors and unnecessary repetition during large volume counting jobs.

Unit Weight Entry Navigator

Simply follow the blinking lights to obtain the unit weight. The HC-i series is very user-friendly! Select your preferred method for unit weight entry; sample size weighing, 10-key pad input or ID number data retrieval.



AWA (Audible Weighing Assist) Beeping Function

The beeping function tells you that you have almost reached your target quantity. The unit begins to make a beeping sound at shorter intervals, making your counting job faster and easier.



ACAI (Automatic Counting Accuracy Improvement)

ACAI automatically corrects errors caused by variation in unit weights. This function provides greater counting accuracy.



DDU Detachable Display Unit

It is possible to put the display unit on a table or wall for diverse counting applications. (Standard cable: 60cm, Optional extension cable HC-08i: 2m)



Comparator Function

Can compare either the count or weight of pieces when the comparator function is activated, "HI", "OK" or "LO" is displayed.



SLA (Sealed Lead Acid) Rechargeable Battery

Optional SLA battery (6V, 4Ah) has an approximate 80-hour battery life when fully charged.



Accumulation Function

Total piece calculation stored in memory. Works in automatic mode or manual mode.



ID Memory Function

Can memorize up to 99 unit weights with tare weight and comparator limits by ID numbers (ID 01 to ID 99).



UFC (Universal Flex Coms)

Can design your own printing format and easily print out the measurement data.



Auto Power-Off function

Battery save function for SLA (Sealed Lead Acid). Switches OFF automatically if zero is displayed continuously for 5 minutes.



Calibration Function

Simple and easy to calibrate with external standard mass by full digital calibration for accurate weighing.



Large LCD Display showing Detailed Information

Displays piece counting, weight, unit weight, ID number, comparison result by "HI", "OK" or "LO" and AC or battery power supply.



COUNT (pcs) Display

The ◀ TOTAL annunciator comes ON when the COUNT display is showing the TOTAL value.

The ◀ M+ annunciator comes ON when counting data is being accumulated.

The ▼ SAMPLE TOO LIGHT annunciator comes ON when the unit weight is too light.



Comparator results, HI/OK/LO.

WEIGHT Display

The ○ STABLE annunciator comes ON when the weighing data is stable.

The ◀ TARE ENTERED annunciator comes ON when the TARE weight is subtracted.

The ◀ ZERO annunciator comes ON when the scale is at ZERO.



UNIT WEIGHT Display

ID Number (2 digits) is displayed when storing or recalling unit weight data.

The ▼ annunciator comes ON when the battery is working.

The ▼ annunciator comes ON when the number of additions to M+ is displayed.

The ▼ ACAI annunciator comes ON when the weight is within the ACAI range. When meeting the ACAI addition range, it will blink.

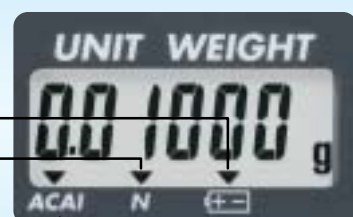



HC-i



The **ON/OFF** key turns the power ON and OFF.



The **ZERO** key returns the scale to ZERO.



The **KEYBOARD TARE** key allows the user to enter a known TARE weight from the 10-key pad.



The **TARE** key subtracts the TARE weight.

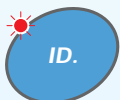

The **ID** key is used when recalling unit weight data from ID memory.



The **KEYBOARD** key is used when a unit weight is to be entered via the 10-key pad.



The **SAMPLE** key is used when entering a sample size.



The **STORE UNIT WEIGHT** key stores the unit weight on display to ID memory.



The **ENTER** key enters Unit Weight, Sample Size, ID or other data into the scale from the 10-key pad.



The **PRINT** key sends Count, Weight or Unit Weight data.



The **TOTAL** annunciator comes ON when the COUNT display is showing the TOTAL value.

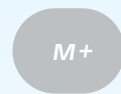

The **M+** key accumulates the count data.



The ***** key displays comparator limits, works as M- key or toggles the weighing units lb/kg.



The  key sets or recalls a target weight using the AWA function.



The **RESET** key clears the Unit Weight data in use.



The 0-9 & . keys send numbers to the display.



The **C** key clears any numbers on the display, which were input using the 10-key pad.



HIC-i

888
LCD Display

FDC
Full Digital Calibration

AAI
Automatic Counting Accuracy Improvement

RS-232C

COMPARATOR

SPLASH

UFC

OFF

ID

Buzzer Function

SLA

AF
Accumulation Function

DDU

Simple



Simple Operation Mode

By setting only the keys necessary for your operation, you can avoid making any unwanted operational mistakes. This mode is available for zero setting, tare weight cancel setting, and sample counting setting.

High Internal Resolution & Wide Counting Range

High internal resolution of 1/600,000 (HC-3Ki / 6Ki / 30Ki) or 1/750,000 (HC-15Ki) is enhanced for greater counting accuracy.

Easy Data Retrieval

It is easy for the user to instantly retrieve article data such as the ID number, unit weight, tare weight and comparator upper/lower limits without any difficulties. It helps to improve the effectiveness and reliability of the operation. Especially effective for multi product lines.

Large Stainless Steel Weighing Pan

Large articles can easily be placed on the weighing pan. The weighing pan is removable and easy to clean.

Interface Function

Optional Interface (RS-232C (HC-03i) and RS-232C + Relay Output (HC-04i)) allows the user to perform diverse applications with Barcode Printer.

Barcode Label Printer AD-8125

Prints out a label detailing ID number, unit weight, weight and quantity. You can design your own labels with the UFC function.

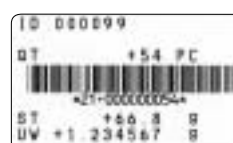

Specifications

	HC-3Ki	HC-6Ki	HC-15Ki	HC-30Ki
Capacity kg	3kg	6kg	15kg	30kg
Resolution kg	0.0005kg	0.001kg	0.002kg	0.005kg
Capacity lb	6lb	15lb	30lb	60lb
Resolution lb	0.001lb	0.002lb	0.005lb	0.01lb
Sample Size	10 pieces normal -5, 25, 50, 100 or random number, user selectable			
Min. Unit Weight*	0.1g / 0.005g	0.2g / 0.01g	0.4g / 0.02g	1g / 0.05g
Internal Resolution	1 / 600,000		1 / 750,000	1 / 600,000
Non-linearity	±0.5g	±1g	±2g	±5g
Repeatability	0.5g	1g	2g	5g
Span Drift	0.002% / °C (5°C~35°C) typ.			
Operating Temp.	-10°C to 40°C / 14°F to 104°F, 85%RH or lower (No condensation)			
Display	7 segment LCD, Character height: pcs 18.6mm, weight/unit weight 11.4mm			
Display Update	Approximately 10 times per second			
Max. Count Display	600,000		750,000	600,000
Interface	RS-232C (option)			
Power	AC adapter or SLA Battery (option) Battery Operating Time : Approx. 80-hour (without interface)			
Platform Size	300 x 210 mm / 11.8 x 8.3 inches			
Dimensions	315(W) x 331(D) x 126(H) mm / 12.4(W) x 13.0(D) x 5.0(H) inches			
Weight (approx.)	4.8kg / 10.6lb			
Calibration Weight	3kg ±0.1g	6kg ±0.2g	15kg ±0.5g	30kg ±1g
Standard Accessories	Instruction manual, AC adapter			

*Min. unit weight varies according to the function setting (F-02-03)

Specifications are subject to change for improvement without notice.

Options

HC-02i Sealed Lead Acid Battery (6V, 4Ah)

HC-03i RS-232C

HC-04i RS-232C + Relay Output

HC-08i Extension Cable (2m)

Accessories

AD-8121B Compact Printer

AD-8118B Journal Printer

AD-8951 Comparator Light

AD-8125 Barcode Label Printer



AD-8121B
Dot Matrix Compact Printer



AD-8951
Comparator Light

External Dimensions (mm/inch)

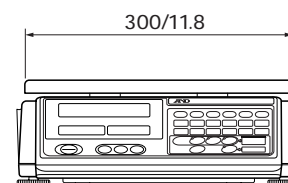
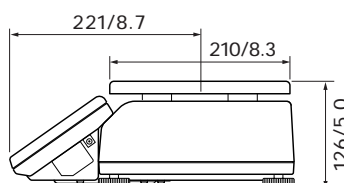
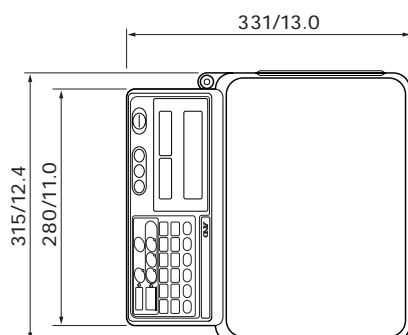

A&D

...Clearly a Better Value

A&D Company, Limited

3-23-14 Higashi-Ikebukuro, Toshima-ku, Tokyo 170-0013 JAPAN
Telephone:[81](3) 5391-6132 Fax:[81](3) 5391-6148
http://www.aandd.jp

A&D ENGINEERING, INC.

1555 McCandless Drive, Milpitas, CA. 95035 U.S.A.
Telephone:[1](408) 263-5333 Fax:[1](408) 263-0119

A&D MERCURY PTY. LTD.

32 Dew Street, Thebarton, South Australia 5031 AUSTRALIA
Telephone:[61](8) 8301-8100 Fax:[61](8) 8352-7409

A&D INSTRUMENTS LTD.

Unit 24/26 Blacklands Way Abingdon Business Park,
Abingdon, Oxon OX14 1DY United Kingdom
Telephone:[44](1235) 550420 Fax:[44](1235) 550485

<German Sales Office>

Große Straße 13 b 22926 Ahrensburg GERMANY
Telephone:[49](0) 4102 459230 Fax:[49](0) 4102 459231

A&D KOREA Limited

Manhattan Bldg. 8F, 36-2 Yoido-dong, Youngdeungpo-gu, Seoul, KOREA
Telephone:[82](2) 780-4101 Fax:[82](2) 782-4280