

Avery Weigh-Tronix

ZM110

DIGITAL BENCH SERIES

Multi-purpose Scale

Technical Specification



ZM110 (400 mm x 400 mm)

ZM110 (400 mm x 500 mm)

ZM110 (500 mm x 600 mm)

DESCRIPTION

The ZM110 with BSL Base can be supplied as a Class III, EC and OIML trade approved bench scale system at 3,000 divisions as well as 6,000 divisions for applications where trade approval is not required. As a system, the BSL Base combines with a pole-mounted indicator that can be used for a wide range of general purpose floor or bench base type applications.

General Weighing: Designed to weigh in lb, kg, or pieces, the ZM110 with BSL Base System can easily be set into sample mode - ideal for counting a wide range of medium sized components.

Checkweighing & Check Counting: Ideal for guaranteeing product or box quantities are within an agreed weight or count size and for repetitive packing applications, the ZM110 Digital Bench Series easily switches between general weighing, checkweighing, and check counting.

Base Construction: With 150% overload protection, powder coated tubular base frames constructed of mild steel, and four corner stops the load cell are well-protected. The base frame is fitted with four large, lockable, adjustable anti-slip feet ideal for leveling the base if positioned on uneven ground.

Load Cell: This base is fitted with a robust, R60 C3 approved, aluminum IP66 load cell

Top Pan: The base is fully covered with a removable, hard-wearing, food grade 304 stainless steel top pan.

Indicator Construction: The ABS housed Avery Weigh-Tronix ZM110 Indicator has a large, easy-to-read 50 mm x 165 mm LCD backlit display with 40 mm high digits and built-in battery that allows this product to be used in low lit areas or in areas where power outlets are hard to find. The ZM110 with BSL Base System can provide over 107 hours of battery life between charges.

SPECIFICATIONS

GENERAL

Operating Applications	General weighing in both kg, lb, Pieces, Basic Counting, Check Counting, Checkweighing
Capacities , Resolutions & Base Dimensions (L x W)	<p>6000d unapproved but EC & OIML approved up to 3000d</p> <p>400 mm x 400 mm base - 60 kg x 0.01 kg (132 lb x 0.02 lb)</p> <p>400 mm x 500 mm base - 150 kg x 0.02 kg (330 lb x 0.05 lb)</p> <p>400 mm x 500 mm base - 300 kg x 0.05 kg (660 lb x 0.1 lb)</p> <p>500 mm x 600 mm base - 300 kg x 0.05 kg (660 lb x 0.1 lb)</p> <p>3000d EC approved E2 Stamped</p> <p>400 mm x 400 mm base - 60 kg x 0.02 kg</p> <p>400 mm x 500 mm base - 150 kg x 0.05 kg</p> <p>400 mm x 500 mm base - 300 kg x 0.1 kg</p> <p>500 mm x 600 mm base - 300 kg x 0.1 kg</p>
Approved Resolution	3000 divisions EC & OIML approved (Class III)
Minimum and Maximum Load Cell Impedance	87 to 1100 ohms

ZM110 DIGITAL BENCH SERIES *Technical Specification*

GENERAL

Calibration	Three points stored (Zero, Span and one optional linerization point if needed)
Analog to Digital Measurement Rate	Configurable from 7.5 to 30 Hz. Default 15 Hz.
Unit of Measure	Allows up to two units of measure plus piece counting (kg, pounds, grams, pounds/ounces). Primary unit of measure kg.
Capacity Selections	Configurable 999,999 with decimal located zero to five places
Division increment	1 to 50 in multiples and sub-multiples of 1, 2, 5
Auto Zero Tracking	Configurable +/- 0 to 5 divisions
Overload Protection	150% overload protection
Gravity Setting	Allows a different gravity to be entered into the scale after calibration
Power Requirements	Supplied with a switching power adapter with interchangeable plug ends to cover UK, EU and Australian plug requirements input 100 - 240 volt ~ 50/60 Hz, 0.4A Max output voltage 12 VDC, 1000mA with positive centre
Battery	Built-in Lead Acid battery (DJW6-4.0 6V 4.0AH) to give up to 107 hours between recharges
Power Save Options	Configurable backlight settings to turn off backlight. When scale is sitting stable for long periods of time, any movement will turn the backlight back on. Auto off feature can be set to turn off the scale when not in use. Auto off from off to 99 minutes.
Enclosure	Housed in a tough, black, ABS enclosure with rear external battery cover with battery installed. Also supplied with detachable, adjustable pole mounting bracket.
Base Dimensions	Available in three base sizes and four main capacities
Base Construction	Powder coated mild steel fabricated top and bottom base frames with a 304 stainless steel removable weight platter and a R60 approved C3 aluminium IP66 load cell.
Built-in Indicator Column	Supplied with 650 mm high stainless steel pole for easily mounting the ZM110 Indicator to the base
Overload Protection	150% overload protection
Feet	Fitted with four large, anti-slip, adjustable, black feet, all with locking nuts

USER INTERFACE

Operational Keys	Eight operation keys (Unit, Select, Print, Zero, Tare x 2, On, Off). Two functional tare keys to accommodate both left and right hand dominant operators.
Status Annunciators	Center of Zero, Motion, Gross, Net, Memory +, Battery Charge
Display	50 mm x 165 mm (2" x 6.5") Large, easy-to-read LCD, backlit display with 40 mm (1.6") high seven digit seven segment display

PHYSICAL

Operating Temperature	-10° to 40° C / 14° to 104° F
Operating Humidity	10 to 90% relative humidity, non-condensing
Shipping Weight	60 kg (132 lb): 13.0 kg (28.7 lb) 150 kg (330 lb): 14.5 kg (32 lb) 300 kg (600 lb): 14.5 kg (32 lb) 300 kg (600 lb): 26.5 kg (58.5 lb)

Dimensions

DIMENSIONS (inches)

Base Size	a	b	c	d	e	f	g	h	i	j	k
15.7" x 15.7"	9.82	15.7	13.46	20.5	13.46	15.7	1.26	35.55	7.48	3.93	3.9
15.7" x 19.7"	9.82	19.7	17.40	24.5	13.46	15.7	1.26	35.55	7.48	3.93	3.9
19.7" x 23.6"	9.82	23.6	21.33	28.4	17.40	19.7	1.26	35.55	7.48	3.93	4.9

DIMENSIONS (millimeters)

Base Size	a	b	c	d	e	f	g	h	i	j	k
400 mm x 400 mm	250	400	342	521	342	400	32	903	190	100	99
400 mm x 500 mm	250	500	442	621	342	400	32	903	190	100	99
500 mm x 600 mm	250	600	542	721	442	500	32	903	190	100	124

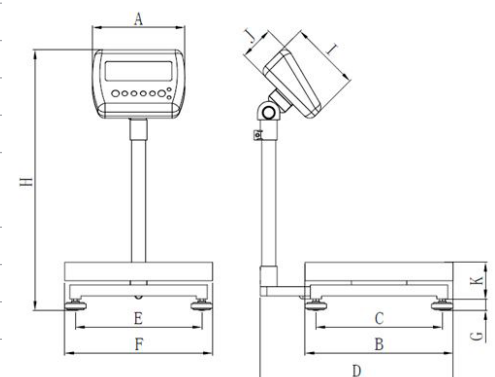

INPUT/OUTPUT

Communications One RS232 optional (distributor fit only)

APPROVALS

Agencies OIML (European and UK) Class III 4,200 d
TEC : 0200-NAWI-05920 OIML CoC for ZM1110: R76/2006-A-DK2-19.04
RoHs II compliant
CE



Avery Weigh-Tronix

www.averyweigh-tronix.com

Avery Weigh-Tronix is an ITW company



Avery Weigh-Tronix is a trademark of the Illinois Tool Works group of companies whose ultimate parent company is Illinois Tool Works Inc ("Illinois Tool Works"). Copyright © 2017 Illinois Tool Works. All rights reserved. This publication is issued to provide outline information only and may not be regarded as a representation relating to the products or services concerned. This publication was correct at the time of going to print, however Avery Weigh-Tronix reserves the right to alter without notice the specification, design, price or conditions of supply of any product or service at any time.

ZM110BenchScale_spec_501862.indd
AWT35-501862