

AD-4410

Weighing Indicator





INSTRUCTION MANUAL



1WMPD4002591A

WARNING DEFINITIONS

The warnings described in this manual have the following meanings:

 WARNING	A potentially hazardous situation which, if not avoided, could result in death or serious injury.
 CAUTION	A potentially hazardous situation which, if not avoided, may result in minor or moderate injury or damage to the instrument.
	This symbol indicates caution against electrical shock. Do not touch the part where the symbol is placed.
	This symbol indicates the ground terminal.
	This symbol indicates that an operation is prohibited.
NOTE	Information or cautions to use the device correctly.

© 2014 A&D Company, Limited. All rights reserved.

No part of this publication may be reproduced, transmitted, transcribed, or translated into any language in any form by any means without the written permission of A&D Company, Limited.

The contents of this manual and the specifications of the instrument covered by this manual are subject to change for improvement without notice.



Contents

1.	Safety Precautions	3
2.	Introduction	4
3.	Specifications	5
3.1.	Analog Section	5
3.2.	Digital Section.....	5
3.3.	General.....	6
3.3.1.	Interface	6
3.3.2.	Measuring functions	6
3.3.3.	Other	7
3.3.4.	Accessories.....	7
3.3.5.	Options.....	7
3.3.6.	Sold separately	7
4.	Description of Each Part.....	8
4.1.	Front Panel.....	8
4.2.	Rear Panel	10
5.	Installation	11
5.1.	Precautions	11
5.1.1.	Environment.....	11
5.1.2.	Power source	12
5.2.	Type of load cell cables	13
5.3.	Connecting the shield wire	13
5.4.	Load Cell Connection	13
5.5.	Checking the load cell connection	15
6.	Operation.....	16
6.1.	General Functions	16
6.1.1.	Zero adjustment	16
6.1.2.	Zero tracking	16
6.1.3.	Tare.....	17
6.1.4.	F key	17
6.1.5.	□ display.....	18
6.1.6.	Memory backup.....	19
6.1.7.	Near zero detection function	19
6.1.8.	Upper or lower limit detection function	19
6.1.9.	Hold function	20
6.2.	Mode Map	22
7.	Calibration	23
7.1.	General Description.....	23
7.2.	Calibration With an Actual Load (<i>LRLEt</i>)	24
7.3.	Dual range.....	26
7.4.	Gravity acceleration correction	26
7.5.	Digital linearization.....	28
7.6.	Calibration-Related Functions (<i>LRLF</i>)	31
7.7.	Linearity-related functions (<i>LrFnc</i>)	38
7.8.	Calibration Errors.....	39
7.9.	Load Cell Output Adjustment.....	40
8.	General Functions	41
8.1.	Setting Procedure.....	41
8.2.	Adjusting the digital filter.....	42

8.3. Basic Functions (F_{ncF})	43
8.4. Hold	45
8.5. Control I/O	46
8.6. Standard Serial (current loop)	47
8.7. RS-232C (Standard) / RS-232C (ch2) / RS-485	48
9. Interface.....	49
9.1. Control I/O	49
9.1.1. Specifications	49
9.1.2. Connection	49
9.2. Serial interface.....	50
9.2.1. Standard serial output (Current loop)	50
9.2.2. RS-232C (ch1)	51
9.2.3. RS-485 (AD4410-03)	52
9.2.4. RS-232C (AD4410-04) (ch2).....	53
9.2.5. Bit structure	54
9.2.6. Data transfer mode	54
9.2.7. Data format	55
9.2.8 Command format	56
9.2.9 Modbus-RTU	61
10. Maintenance	64
10.1. Error Messages	64
10.2. Check Mode	64
10.2.1. Entering the check mode.....	64
10.2.2. Checking the key switches	65
10.2.3. Checking the standard serial output.....	65
10.2.4. Checking the RS-232C	66
10.2.5. Checking the RS-232C / RS-485 (Option).....	66
10.2.6. Checking the control I/O.....	66
10.2.7. Checking the A/D (load cell).....	66
10.2.8. Checking the internal count.....	66
10.2.9. Checking the program version	67
10.2.10. Checking the serial number.....	67
10.2.11. Checking the program checksum.....	67
10.2.12. Checking the FRAM checksum	67
10.2.13. Checking the calibration-related functions.....	67
10.3. Initialization Mode.....	68
10.3.1. RAM initialization / General functions initialization	68
10.3.2. All data initialization.....	69
10.4. Confirming the load cell connection with a digital multi meter	70
11. Setting List.....	72
11.1. Basic Functions	72
11.2. Hold	74
11.3. Control I/O	75
11.4. Standard Serial Output	76
11.5. RS-232C (Standard) / RS-232C (ch2) / RS-485	77
11.6. Linearity-Related	78
11.7. Calibration-Related.....	79
12. External Dimensions.....	81



1. Safety Precautions

For safe and correct usage, read the following precautions carefully before using the indicator.

Grounding

Be sure to ground the AD-4410 when using it.

Do not use the same grounding wire that power-driven equipment such as motors or inverters are using.

Accidents such as electrical shocks, fire, or malfunctions may occur if the instrument is not grounded properly.

Using proper power cables

Be sure to use the provided power cable.

If you wish to use a cable other than the provided cable, be sure to use a cable matching the voltage and current of the power source.

It may cause an accident such as electrical leakage or fire if a cable with insufficient pressure-resistance is used.

Fuse replacement

A fuse is provided to protect against a short circuit and possible fire hazard.

The indicator is equipped with various protection circuits and the fuse should not burn out under normal operations.

If the fuse burns out, the internal circuits may have been damaged by surges. Do not try to replace the fuse. Contact the nearest A&D dealer.

Avoid water and moisture

The indicator is not water-resistant.

Securing the front panel to the control panel using the accessory panel mount packing will provide the indicator with IP-65 protection.

Avoid an environment with flammable gases

Do not use the indicator in places where flammable gases are present.

Indicator overheat

To prevent the indicator from overheating, allow appropriate clearance between the peripheral devices.

If the ambient temperature exceeds the specified operating temperature, use a fan to cool the environment.



2. Introduction

- The AD-4410 is a weighing indicator that amplifies signals from a load cell, converts it to digital data and displays it as a mass value.
- The accessory panel mount packing will provide the indicator with IP-65 protection.
- This indicator has the following performance:
 - Input sensitivity: 0.15 $\mu\text{V}/\text{d}$
 - Display resolution: 999,999 d max.
(Less than 20,000 d recommended)
 - Sampling rate:..... 100 times/second
 - Input voltage range:..... -35 mV to +35 mV (-7 mV/V to +7 mV/V)
- Dual range
Divides the weighing range into two and displays the net weight or gross weight with an appropriate scale interval, depending on the value.
- Gravity acceleration correction
Calculates a correction for instances when gravity acceleration differs in the place where the scale was calibrated and the place where measurement is being conducted.
- Digital linearization
Nonlinearity correction feature to correct weighing errors that occur halfway between the zero point and weighing capacity. It is possible to input up to four points in addition to the zero point. Areas between the inputted points will be nonlinearly corrected.
- Digital span mode:
Keying in the load cell output voltage (mV/V) allows calibration to be performed without an actual load.

NOTE: The unit “d” indicates a minimum division.



3. Specifications

3.1. Analog Section

Input sensitivity	0.15 $\mu\text{V}/\text{d}$ or greater	
Input voltage range	-35 mV to +35 mV (-7 mV/V to +7 mV/V)	
Zero adjustment range	-35 mV to +35 mV (-7 mV/V to +7 mV/V)	
Load cell excitation voltage	5VDC $\pm 5\%$, 120 mA with remote sensing capability	
Load cell drive capacity	Maximum 8 x 350 Ω load cells	
Temperature coefficient	Zero	$\pm 0.02 \mu\text{V}/^\circ\text{C}$ typ., $\pm 0.1 \mu\text{V}/^\circ\text{C}$ max.
	Span	$\pm 3\text{ppm}/^\circ\text{C}$ typ., $\pm 15\text{ppm}/^\circ\text{C}$ max.
Nonlinearity	0.005 % of full scale	
A/D conversion method	Delta-sigma method	
A/D resolution count	Approximately 16,000,000 counts	
Display resolution	999,999 d max. (Less than 20,000 d recommended)	
Sampling rate	100 times/second	

3.2. Digital Section

Display element	<ul style="list-style-type: none">• Measurement display: 6-digit 7-segment green LED• Character height: 14.6 mm• Polarity display: 1 green LED• Status indicators: 6 red LEDs
Measurement display	<ul style="list-style-type: none">• Switches between NET and GROSS• Selectable decimal places (10^1, 10^2, 10^3, 10^4, 10^5)• Overflow display All the digits turn OFF. (When the polarity is negative, the minus sign appears at the highest-order digit.)
Status indicators	ZERO, STABLE, GROSS, NET, HOLD, \square
Key switches	ZERO, TARE, NET/GROSS, F, ON/OFF, ENTER, CAL

3.3. General

3.3.1. Interface

Control I/O	Input: open collector Output: photo coupler DIN connector 8 pin
Standard serial output	Output for communication with A&D peripheral devices (20 mA current loop) DIN connector 7 pin
RS-232C (Standard equipment)	D-sub 9 pin male
RS-232C/RS-485 (Option)	It is possible to change the current loop to the RS-232C (ch2) or RS-485. RS-232C AD4410-04 RS-485 AD4410-03

3.3.2. Measuring functions

Zero adjustment	<ul style="list-style-type: none"> • Sets the gross weight to zero by pressing the ZERO key. • Selection of disable or enable for the operation when unstable. • The zero value is stored in the non-volatile memory. • Zero adjustable range Can be set optionally in the range of 1 to 100% of the weighing capacity.
Zero tracking	<ul style="list-style-type: none"> • Tracks the weight drift around the zero point to maintain zero. • Zero tracking time 0.0 to 5.0 seconds (Can be set optionally within the range.) • Zero tracking band 0.0 to 9.9 d (Can be set optionally within the range.)
Tare	<ul style="list-style-type: none"> • Sets the net weight to zero by pressing the TARE key. • Selection of disable or enable for the operation when unstable or negative. • The tare weight is stored in the non-volatile memory. • Tare range: Gross weight \leq Weighing capacity
Stability detection	<ul style="list-style-type: none"> • Turns ON the stabilization indicator when the variables of the weight values per sampling are within the set band in the set time. • Stability detection time 0.0 to 9.9 seconds (Can be set optionally within the range.) • Stability detection band 0 to 9 d (Can be set optionally within the range.)
Digital filter	Cutoff frequency range (-3dB) : 0.07 to 11 Hz
Near zero detection function	Detects whether there is a load or not and outputs the result as near zero.
Comparison function	HI, OK, or LO is output by comparing a value to an upper or lower limit value.
Hold function	This is displayed by holding the weighing value. Normal hold / Peak hold / Averaging hold

3.3.3. Other

Data backup against power failures	<ul style="list-style-type: none">• Zero value, tare weight, calibration data and function data are written into the FRAM.• Data retention time is 10 years or more.
Power source	Rated power voltage range of main body 100 VAC to 240 VAC (50/60 Hz Allowance power voltage range 85 VAC to 250 VAC) Rated power voltage range when using provided power cable (C plug) 100 VAC to 120 VAC (50/60 Hz)
Power consumption	Approximately 10 VA
Operating temperature	-10°C to +40°C
Operating humidity	85% R.H. or less (no condensation)
Installation method	Panel mount
Mass	Approximately 800 g

3.3.4. Accessories

Item	Quantity	Model name, other
Weighing capacity plate	1	108-4030167
Unit label	1	108-4023456
Panel mount packing	1	106-4004213
Rubber foot	4	110-NO.5837
DIN connector 7 pin	1	AX-TCP0576-S
DIN connector 8 pin	1	1JA-TCP0586
Load cell connector	1	AX-NJC-207-PF
Power cable	1	AX-KO115
Grounding adapter	1	1ET-MK-18

3.3.5. Options

Model name	Description
AD4410-03	RS-485
AD4410-04	RS-232C
AD4410-11	Stand

3.3.6. Sold separately

Model name	Description
AX-TCP0576-S	DIN connector 7pin
AX-NJC-207-PF	Load cell connector
AX-KO115	Power cable



4. Description of Each Part

4.1. Front Panel

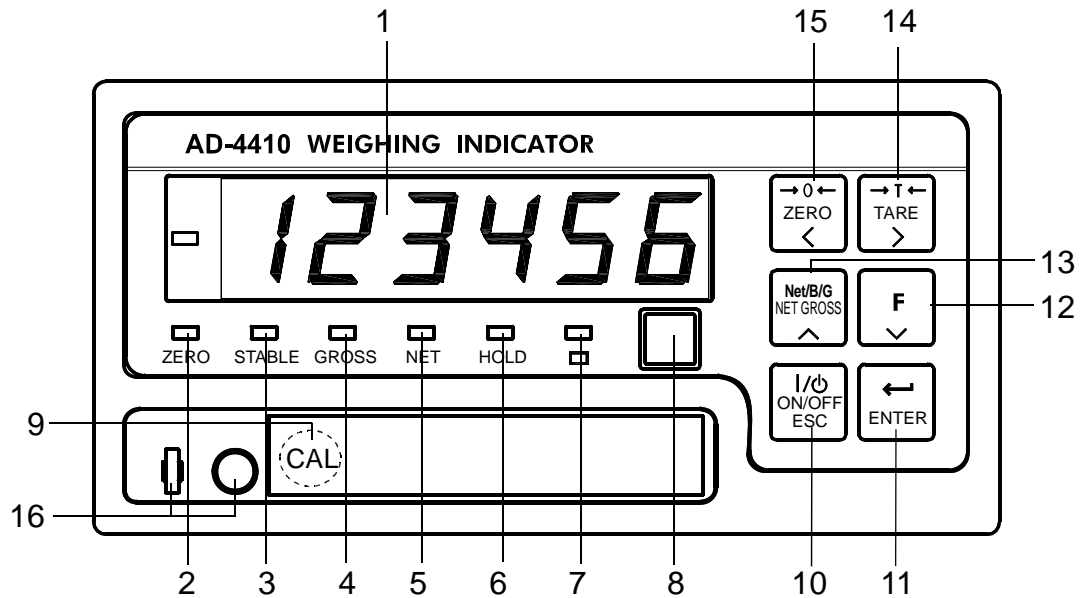





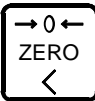

Fig.1 Front panel

Displays

No.	Name	Description
1	Main display	Displays the weight value, setting values, error messages, etc.
2	ZERO	Turns ON when the weight value is in the center of zero.
3	STABLE	<ul style="list-style-type: none"> • Turns ON when the weight value is stable. • The stability conditions can be changed in the calibration-related functions.
4	GROSS	Turns ON when the displayed value is a gross weight.
5	NET	Turns ON when the displayed value is a net weight.
6	HOLD	<ul style="list-style-type: none"> • Turns ON when the weight value is being held. • Two hold modes can be selected in the general functions, either normal hold or peak hold.
7		The function for this indicator can be selected in the general functions, depending on the purpose.
8	UNIT	<ul style="list-style-type: none"> • Place a unit label. • A unit used for weighing is set in the calibration-related functions.

Key switches

No.	Name	Description
9	CAL	<ul style="list-style-type: none"> • The key to enter the calibration mode. • The key is concealed by a sealable cover. To avoid unintentional operations, keep the cover attached except when entering the calibration mode.
10		<ul style="list-style-type: none"> • The key to turn the indicator ON (Weighing mode) and OFF (OFF mode). To turn the indicator OFF (OFF mode), press and hold this key. • When OFF, all of the displays and external output/input devices are turned OFF, but a decimal point located at the right side of the main display remains ON. • The key functions as an ESC key when the numerical values are being entered.
11		<ul style="list-style-type: none"> • The key to proceed to the selected mode. • Stores the data when pressed after a setting is changed.
12		<ul style="list-style-type: none"> • The function for this key can be selected in the general functions, from the list below: <ul style="list-style-type: none"> No function Manual print command Hold Alternate switch Momentary switch Clear the tare weight Clear the zero value • The key decreases the value of the blinking digit by one when the numerical values are being entered.
13		<ul style="list-style-type: none"> • The key to switch between the gross weight and the net weight. • The key increases the value of the blinking digit by one when the numerical values are being entered.
14		<ul style="list-style-type: none"> • The key to perform tare. • The tare conditions are set in the calibration-related functions. • The key shifts the position of the blinking digit to the right when the numerical values are being entered. • In the OFF mode, pressing the ON/OFF key while holding the TARE key will clear the zero value and the tare weight.
15		<ul style="list-style-type: none"> • The key to zero the current display. • The zero conditions are set in the calibration-related functions. • The key shifts the position of the blinking digit to the left when the numerical values are being entered.
16	Seal	<ul style="list-style-type: none"> • Cover be sealed using a wire seal.

4.2. Rear Panel

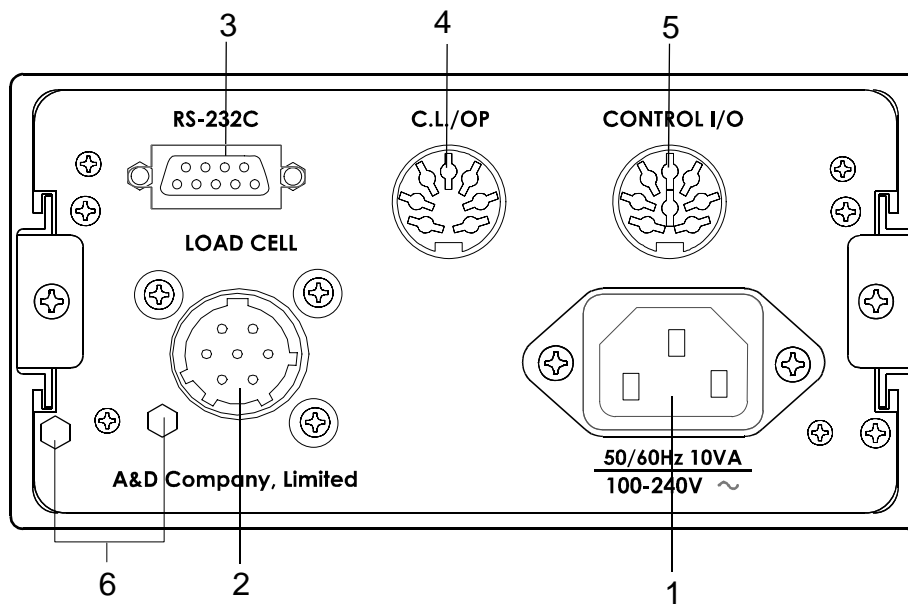

Fig.2 Rear panel

No.	Description
1	AC power plug
2	Load cell terminal
3	Standard serial output (RS-232C output)
4	Standard serial output (Current loop output) As an option, the current loop output can be changed to RS-485 or RS-232C (ch2).
5	Control I/O
6	Sealing bolt Can be sealed with wire.



5. Installation

⚠ CAUTION

The weighing indicator is a precision electronic instrument. Handle it carefully.

5.1. Precautions

5.1.1. Environment

- The operating temperature range is -10°C to $+40^{\circ}\text{C}$.
- Do not install the indicator in a position where it is exposed to direct sunlight.
- The indicator is not water-resistant. When used in an environment where the indicator may be exposed to splashing water, secure the front panel to the control panel using the accessory panel mount packing. This makes the front panel water-resistant equivalent to IP-65.

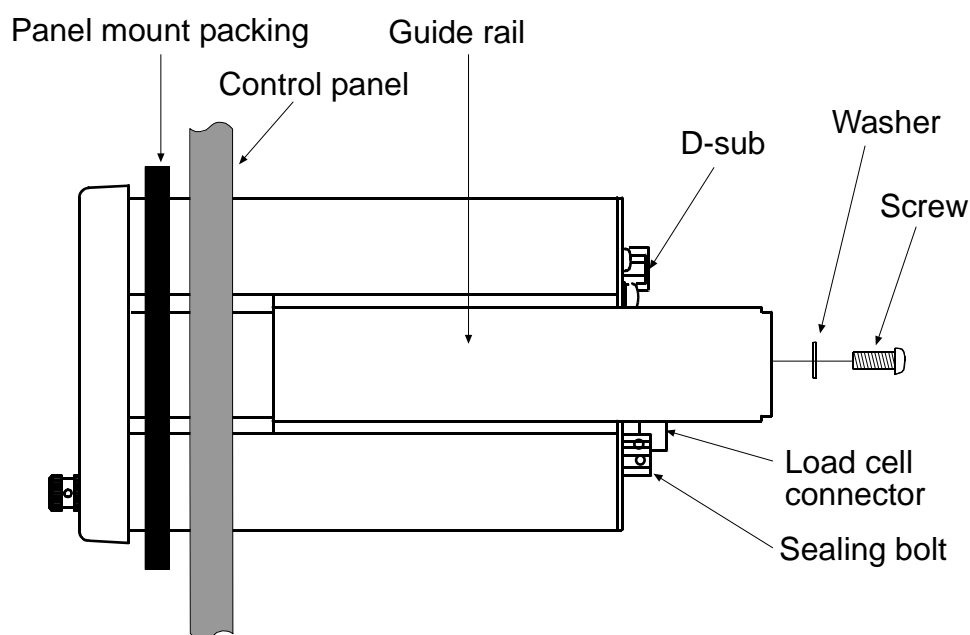

Fig.3 Panel mounting method

5.1.2. Power source



Earth ground the indicator to prevent electrical shock or indicator malfunction.

- Before connecting the indicator to the power source, read the instruction manual thoroughly.
- Do not connect the indicator to the power source before the installation is complete.
- ⚠ □ To avoid electrical shock, do not handle the power cable with wet hands.
- ⚠ □ Earth ground the indicator. Do not share the ground line with other electrical power equipment.
- The power requirement is 100 VAC to 240 VAC and the frequency is 50 Hz or 60 Hz. Use a stable power source free from instantaneous power failure or noise.
- To avoid a malfunction, do not share the power line with other devices.
- The output voltage of a load cell is a very sensitive signal. Keep all electrical noise sources away from the load cell and load cell cable.
- Use shielded I/O cables. Connect the cable shield to the F.G. terminal or the indicator housing.

5.2. Type of load cell cables

The load cell cable must have high insulation and shield performance.

Use a shield cable that is made with a material with high insulation resistance, such as Teflon or polyethylene.

For best results, we recommend using A&D's load cell cables.

AX-KO162-5M to 100M (5m to 100m)

Cable diameter... ϕ 9mm

Cross-sectional area of the conductor...0.5mm² 6 wire cable equipped

5.3. Connecting the shield wire

Connect the shield wire of the load cell cable to only the shield terminal (7th pin of the load cell connector) of the AD-4410.

As a general rule, do not ground between the load cell and AD-4410. This is because when there are multiple ground points, a ground loop can be created along the wiring route, and interference such as high-frequency noise becomes more likely.

5.4. Load cell connection

Connecting the shield wire

As a general rule, only connect the load cell cable's shield wire to the weighing indicator's shield terminal. This is because when there are multiple ground points, it becomes easier for noise to occur as a result of a ground loop. However, when there are higher priorities than noise prevention, such as explosion prevention systems or static electricity release routes, this rule does not necessarily need to be followed.

Connecting the signal wire

AD-4410 has two connection configurations: the 6-wire configuration and the 4-wire configuration.

We recommend connecting using the 6-wire configuration for optimum accuracy and stability.

Terminal No.	Function	
1	EXC+	Load cell excitation voltage (+)
2	SEN+	Sensing input (+)
3	SEN-	Sensing input (-)
4	EXC-	Load cell excitation voltage (-)
5	SIG+	Load cell input (+)
6	SIG-	Load cell input (-)
7	SHIELD	Shield

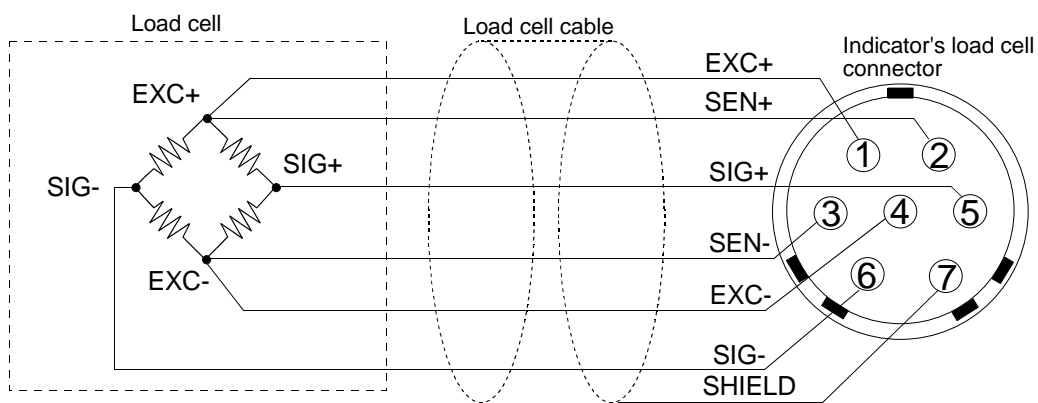

(A) 6-wire configuration connection to load cell (recommended)

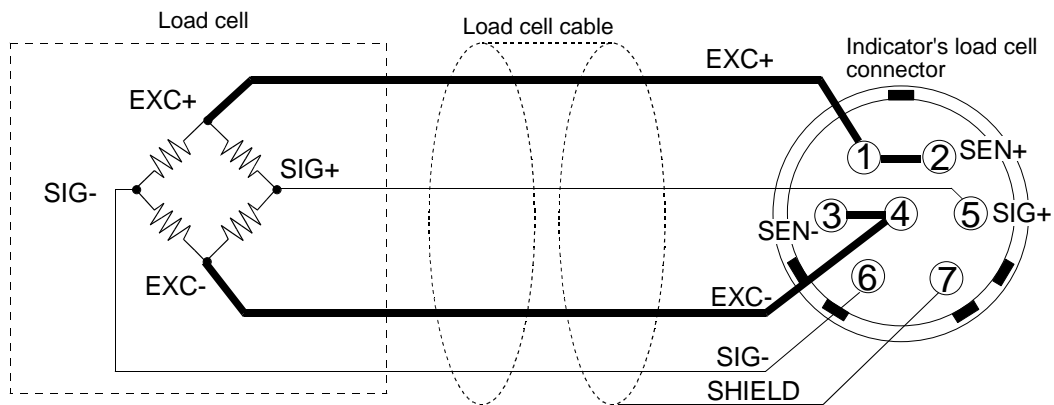

(B) 4-wire configuration connection to load cell (not recommended)

Fig.4 Load cell connection configuration

Method	Merit	Demerit	Description
6-wire configuration (recommended)	Even if load cell cables are lengthened or thin load cell cables are used, error margins are kept low. Error margins are also kept low where multiple load cells are used.	Wiring is somewhat difficult.	When using a summing box, we strongly recommend using the 6-wire configuration.
4-wire configuration	Wiring is easy.	The temperature coefficient will be negatively affected by the lead resistance of the load cell cable. Contact resistance from the connector etc. will also have an effect.	Errors become more likely when lengthened load cells or multiple load cells are used.

Precautions to be taken when using the 4-wire configuration:

If the 4-wire configuration has to be used, please take the following measures.

- Be sure to connect terminals 1 and 2 (EXC+ and SEN+) and terminals 3 and 4 (SEN- and EXC-).
- When lengthening the load cell cable, try to use cable with a large cross-sectional area. Also, keep the cable as short as possible.

5.5. Checking the load cell connection

Once the load cell has been connected, perform a connection check using the following procedure.

1. Perform a visual check to ensure that there are no wiring mistakes.
2. Turn the AD-4410 ON.
When calibration has not yet been carried out, the display value may be blank. However, as long as there are no problems with the display, confirmation can still be carried out using check mode.
3. Confirm the output value of the load cell by using check mode.
Refer to “10.2. Check Mode”, and start check mode for the A/D (load cell).
4. Confirm that the displayed load cell output value matches the specified value.
As a general rule, the displayed value should become the rated output value of the load cell or less.
5. Refer to “10.4. Confirming the load cell connection with a digital multi meter” if there is an issue with the indicator, and check the connection.



6. Operation

6.1. General Functions

6.1.1. Zero adjustment

- Zero adjustment is a function to set the gross weight to zero. It is performed by pressing the ZERO key.
- The zero adjustment range is set in *CALF05* (zero adjustment range) and is expressed as a percentage of the weighing capacity with the calibration zero point as the center.
- Zero adjustment is disabled, even within the zero adjustment range, if an A/D converter overflow occurs.
- A ZERO error is output if zero adjustment is not performed.
- The zero value is stored in the non-volatile memory and is maintained, even if the power is disconnected.
- Clearing the zero value is performed using the F key assigned to clear the zero value. Alternately, apply power to the indicator while holding the TARE key, or with the indicator in the OFF mode, press and hold the TARE key and press the ON/OFF key to clear the zero value.

Functions related to zero adjustment

- *CALF05*: Changes the zero adjustment range. (0 to 100%)
- *CALF10*: Enables or disables zero adjustment when unstable.
- *CALF16*: Enables or disables power-ON zero function (to zero upon power-ON).

6.1.2. Zero tracking

- Zero tracking is a function to track the weight drift around the zero point to maintain zero.
- The zero tracking time is set in *CALF06* (zero tracking time) and the zero tracking band is set in *CALF07* (zero tracking band). When the weight drift is within the specified ranges, zero adjustment is performed automatically.
- A ZERO error is not output even if zero tracking is not performed.

Functions related to zero tracking

- *CALF06*: Changes the zero tracking time. (0.0 to 5.0 seconds)
- *CALF07*: Changes the zero tracking band. (0.0 to 9.9 d)

6.1.3. Tare

- Tare is a function to store the gross weight as the tare value and set the net weight to zero.
- The tare weight is stored in the non-volatile memory and is maintained, even if the power is disconnected.
- Clearing the tare weight is performed using the F key assigned to clear the tare weight. Alternately, apply power to the indicator while holding the TARE key, or with the indicator in the OFF mode, press and hold the TARE key and press the ON/OFF key to clear the tare weight.

Functions related to tare

- *[ALF 10]*: Enables or disables tare when unstable.
- *[ALF 11]*: Enables or disables tare when the gross weight is negative.

6.1.4. F key

- Assign a function to the F key in the general functions.

Functions related to the F key

- *FncF02*: Assigns a function to the F key from the functions below:

0: None

1: Manual print command

2: Hold

3: Alternate switch (Read the description below.)

4: Momentary switch (Read the description below.)

5: Clear the tare weight

6: Clear the zero value

- *[ALF 15]*: Enables or disables clearing the zero value.
- *[ALF 20]*: Enables or disables the print command when the gross weight is negative.

Alternate switch and momentary switch

- By assigning these switches to the F key, the ON/OFF status of the F key can be transmitted to the master station. This is useful when building a network or performing maintenance.
- By selecting “3: F key status” for *FncF04* (□ display), the ON/OFF status of the F key can be confirmed by the memory in sync with the □ display.
- These switches perform as below:

Alternate switch

Press the switch once and release the switch to turn ON or OFF.

Press the switch again to turn OFF or ON.

Momentary switch

Only when the switch is being pressed, the F key is ON. When released, OFF.

6.1.5. □ display

- Assign a function to the □ display in the general functions.

Functions related to the □ display

● *FncF04*: Assigns a function to the □ display from the functions below:

- 0: None
- 1: Zero tracking in progress
- 2: Alarm (Zero range setting error, over limit)
- 3: F key status (Read the description below.)
- 4: Near zero
- 5: HI output (Over upper limit)
- 6: OK output (Within upper and lower limits)
- 7: LO output (Below lower limit)
- 8: User input 1
- 9: User input 2
- I0: User input 3
- I1: User output 1
- I2: User output 2
- I3: User output 3

F key status

- Enables when alternate switch or momentary switch is selected for *FncF02* (F key).
The □ display turns ON when the F key is ON and turns OFF when the F key is OFF.

About user input and user output

User I/O can be used for any purpose the user wishes. It will not have any direct effect on the weighing instrument's operation. Using RS-232C or RS-485 interface commands, one can turn on certain output terminals or check the status of certain input terminals using the □ display on the front panel.

Usage examples

Example 1)

You would like to monitor the input of a photo sensor with a computer, but you don't have an input port that can work with it.

- Connect the photosensor to a control input terminal that is assigned to the user input.
- Using RS-232C/485 IOU commands, monitor the control input connected to the photo sensor.

Example 2)

You would like to remotely control the relay via computer, but you don't have a usable output port.

- Connect the relay to a control output terminal that is assigned to the user output.
- Monitor the control output terminal, connected to a solenoid, with RS-232C/485 IOU commands.

Example 3)

With the AD-4410's front panel, you want to monitor a computer running a relay.

- Using the □ display function, set the user output terminal you want to monitor.

Because the AD-4410's control I/O terminal is well-insulated, it can prevent noise interference with computers created by issues such as relays.

6.1.6. Memory backup

Zero value, tare weight, calibration data and function data are written into the FRAM. FRAM is a non-volatile memory and does not require batteries.

The data retention period is 10 years.

6.1.7. Near zero detection function

Near zero is a function to detect whether an object has been placed on the weighing pan.

A near zero state is when the weighing value is within the set value for the near zero range.

Related functions

- When setting a comparative value for near zero:

Set using $FncF08$ (near zero value setting)

- When selecting an item to be compared with the near zero value:

Select gross weight or net weight using $FncF09$ (comparison weight of near zero)

6.1.8. Upper or lower limit detection function

This is a function to detect whether the weighed value is above an upper limit value or below a lower limit value.

Related functions

- When setting a comparative upper or lower limit value:

Set using $FncF10$ (set upper limit value) or $FncF11$ (set lower limit value)

- When selecting an item to be compared with the upper or lower limit value:

Select gross weight or net weight using $FncF12$ (weight compared with upper and lower limits)

- When selecting logic to output the upper or lower limit:

Select positive logic or negative logic using $FncF13$ (logic output for upper and lower limits)

6.1.9. Hold function

There are three types of hold functions which can be used for different purposes.

1. Normal hold

Holds the value displayed at the time the hold command was received.

2. Peak hold

Holds the maximum value reached after the hold command was received.

The value will be refreshed if it increases again.

3. Averaging hold

This function averages weighing data over a certain period of time and then holds the result.

It is useful for measuring things that are difficult to weigh such as an animal that won't settle down, or for averaging out the weight of an object in an unstable state. In addition, it can reduce the effects of breezes which the digital filter cannot eliminate.

Related functions

- To select the type of hold function:

Select the type of hold function with $FncF07$ (hold)

- To set operating conditions for the hold function:

Set the averaging time length, standby time, or start and stop conditions with $HLdF01$ to 07 . (Will not affect normal holds)

Peak hold

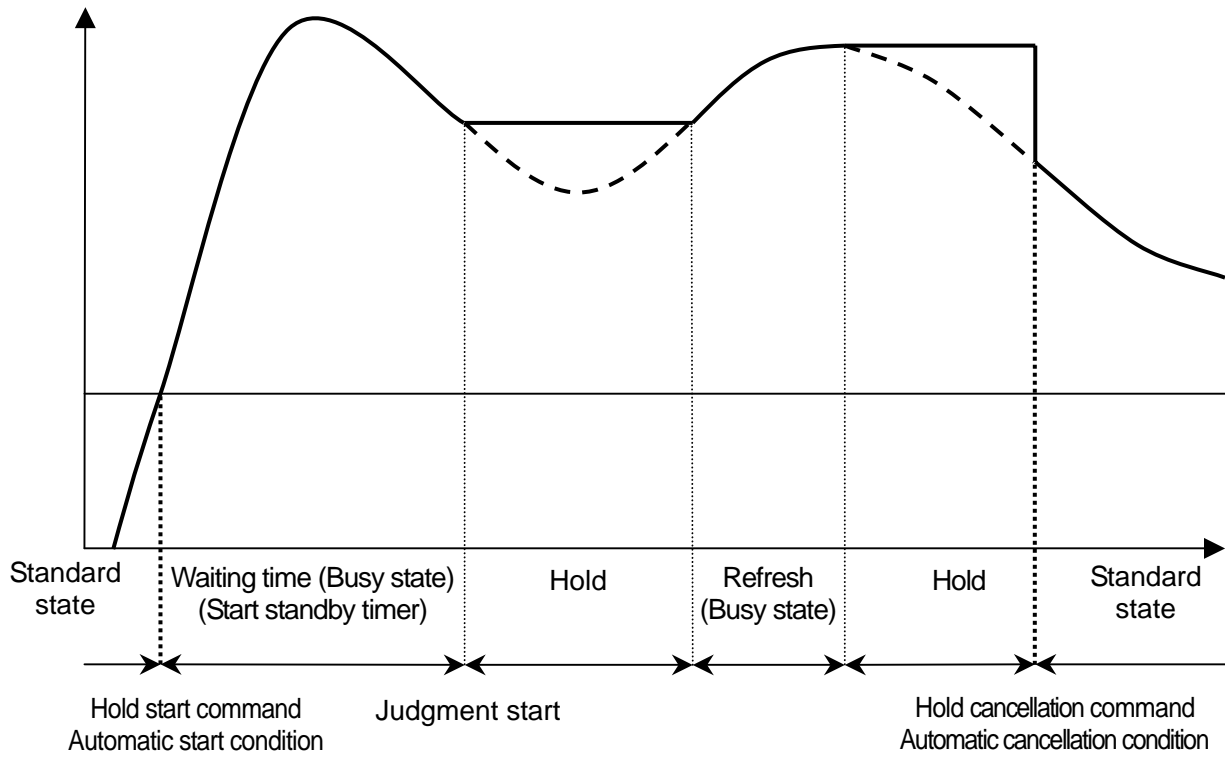

Averaging hold

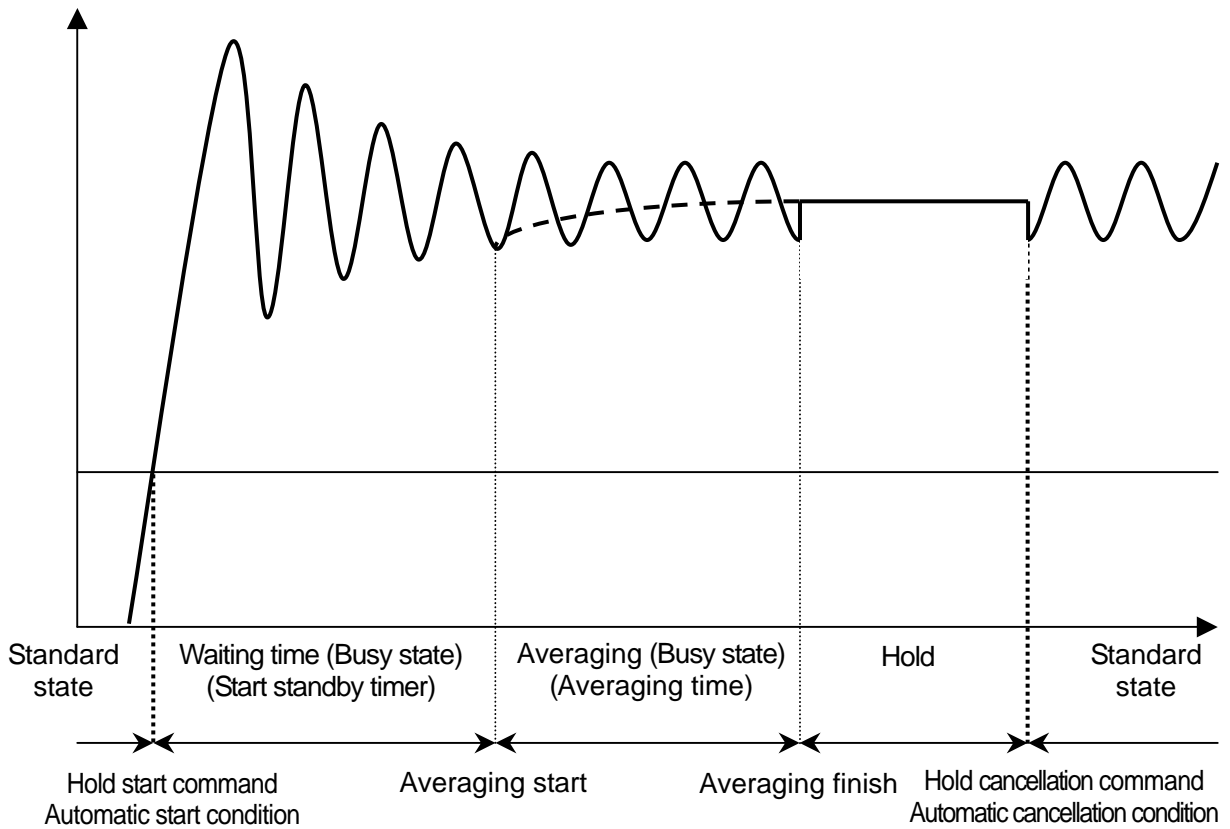

Fig.5 Peak hold / Averaging hold

6.2. Mode Map

The indicator has several modes to perform various operations.

Perform mode switching by the key operation shown below, only in the direction of the solid arrow.

After setting a mode, the indicator resets automatically. Alternatively, the indicator resets when the power is disconnected.

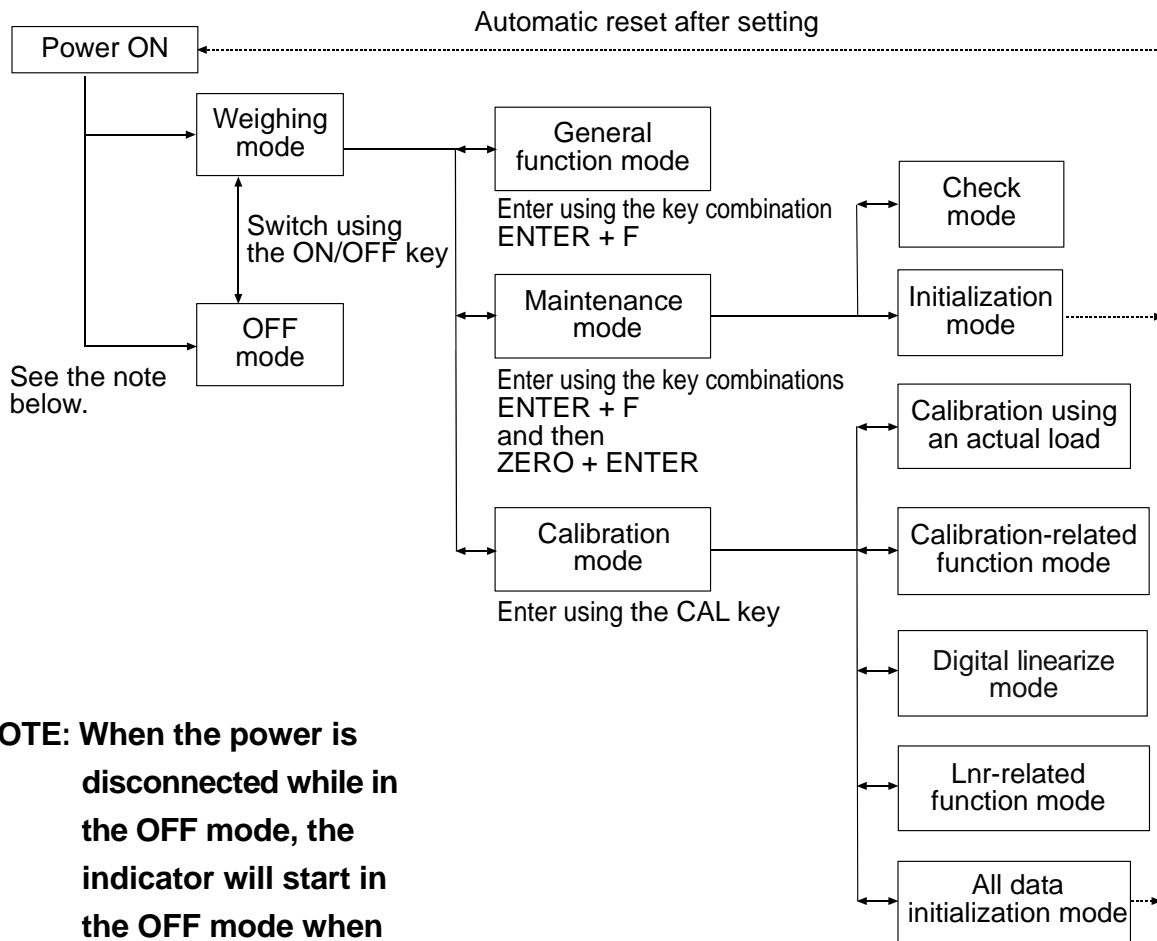

Fig.6 Mode map



7. Calibration

7.1. General Description

In the calibration mode, the operation to relate the output voltage from a load cell to the actual weight value and other operations directly related to weighing are performed.

Calibration with an actual load	<p>Calibration is performed using a calibration weight.</p> <ul style="list-style-type: none">• Zero calibration: Adjusts the indicator so that the measured value will be zero when no load is applied to the load cell.• Span calibration: Enter the calibration weight value and place the calibration weight on the load cell. <p>When the indicator enters the mode of calibration with an actual load, the tare weight and the zero value will be automatically cleared.</p>
Digital span	<p>Calibration is performed without an actual load, by keying in the load cell output voltage (mV/V).</p> <ul style="list-style-type: none">• Input voltage at zero: Key in the load cell output at zero.• Input voltage at span: Key in the load cell output at span. (Load cell output at full capacity – load cell output at zero)• Calibration weight value at span: Key in the calibration weight value corresponding to the input voltage at span. (The input voltage at span is related to the weight value.)
Dual range	<p>Divides the weighing range into two and displays the net weight or gross weight with an appropriate scale interval, depending on the value.</p>
Gravity acceleration correction	<p>Calculates and corrects for gravity acceleration if the location where the instrument was calibrated and the location it is being used in are different.</p>
Digital linearization	<p>Nonlinearity correction feature to correct weighing errors that occur halfway between the zero point and weighing capacity. Up to 4 points can be input in addition to the zero point, and the intervals between each point will be calculated using curves.</p>
Calibration-related function	<p>Setting basic constant values of the indicator such as the minimum division and weighing capacity and other data directly related to weighing is performed.</p> <p>Setting the parameters for digital span calibration, dual range or gravity acceleration correction is also performed.</p>
All data initialization	<p>Clears all the data such as zero value, tare weight, calibration data and function data.</p>

NOTE: All the data set in the calibration mode is stored in the FRAM.

7.2. Calibration With an Actual Load (CALSET)

Calibration is performed using a calibration weight

Before performing calibration for the first time, set the unit, decimal point position, minimum division and weighing capacity in the calibration-related function mode.

NOTE: To avoid drift caused by changes in temperature, warm up the indicator for ten minutes or more before performing calibration with an actual load.

Step 1 Press the ON/OFF key to turn the indicator ON (weighing mode) if it is in the OFF mode.

Remove the CAL key cover and press the CAL key.

CAL is displayed to indicate that the indicator has entered the calibration mode.

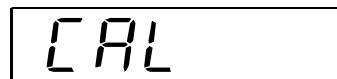

Step 2 Press the ENTER key to display **CALSET**.

The indicator enters the mode of calibration with an actual load. To go back to the weighing mode, press the ESC key.

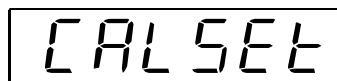

Zero calibration

Step 3 Press the ENTER key to display **CAL 0**.

If zero calibration is not to be performed, press the F key and go to step 5.

To monitor the current weight value, press the CAL key. Press the CAL key again to display **CAL 0**.

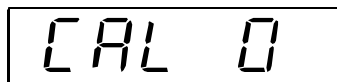

Step 4 With nothing placed on the load cell, wait for the stabilization indicator to turn ON and press the ENTER key. **- - - - -** is displayed for approximately two seconds.

If span calibration is not to be performed, press the ESC key twice to return to the weighing mode.

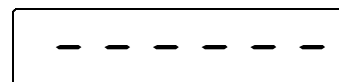
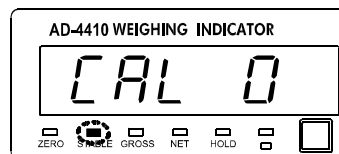

Span calibration

Step 5 Press the ENTER key when **CALSPn** is displayed.

The calibration weight value (the weighing capacity currently set) is displayed and the lowest value number blinks.

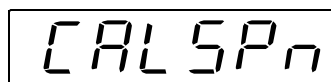

◀ ▶ ▲ ▼ keys: Press to correct the value of the calibration weight used.



[CAL] key : Press to check the current value (the gross weight) and press again to display the calibration weight value.



[ESC] key : Press three times to go back to the weighing mode without performing span calibration.

Step 6 Place a calibration weight on the load cell. Wait for the stabilization indicator to turn ON and press the ENTER key. **[-----]** is displayed for approximately two seconds.

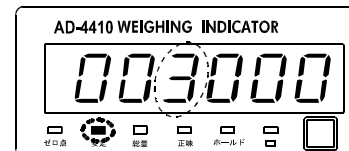

Step 7 **[CALEnd]** is displayed. To re-adjust the span, press the F key.

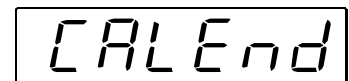

Step 8 Press the ESC key. **[CALSEt]** is displayed and the calibration data is written into the FRAM.

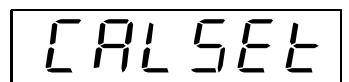

Step 9 The current state is the same as that of step 2. To go back to the weighing mode, press the ESC key again.

NOTE: The blinking decimal point indicates that the current value is not the weight value.

If **[ErrX]** is displayed, an error has occurred. Refer to “7.8. Calibration Errors” to take some measures.

7.3. Dual range

Dual range is a function that divides the weighing range into two and displays the net weight or gross weight with an appropriate scale interval, depending on the value.

This function is a feature of a dual range instrument.

Setting of the range and division

Set the following items using these calibration-related functions

[ALF03]: minimum division	Scale interval of the first range
[ALF04]: weighing capacity	Upper limit of the second range
[ALF24]: scale interval of dual range	Scale interval of the second range
[ALF25]: dual range border	Upper limit of the first range

* Make sure you set the scale interval for the second range to a larger value than the first range.

* Set the dual range's border so that it is a smaller value than the weighing range.

7.4. Gravity acceleration correction

- When the scale (indicator) has been calibrated in the same place as it is being used, gravity acceleration correction is not required.

- A span error will appear if there is a gravity acceleration difference between the place where the instrument has been calibrated and the place it is being used.

The gravity acceleration correction calculates and corrects this span error by setting gravity acceleration correction values for both points (the place it was calibrated and the place it is being used in).

* When the span is calibrated with actual load calibration, the gravity acceleration correction settings are cleared, and the two gravity acceleration settings return to their default values.

Set gravity acceleration

Set the following items with these calibration-related functions

[ALF26]: gravity acceleration of the place of calibration	Gravity acceleration of the place where the instrument was calibrated.
[ALF27]: gravity acceleration of the place of usage	Gravity acceleration of the place where the instrument is being used.

Gravity Acceleration Table

Amsterdam	9.813 m/s ²	Manila	9.784 m/s ²
Athens	9.800 m/s ²	Melbourne	9.800 m/s ²
Auckland NZ	9.799 m/s ²	Mexico City	9.779 m/s ²
Bangkok	9.783 m/s ²	Milan	9.806 m/s ²
Birmingham	9.813 m/s ²	New York	9.802 m/s ²
Brussels	9.811 m/s ²	Oslo	9.819 m/s ²
Buenos Aires	9.797 m/s ²	Ottawa	9.806 m/s ²
Calcutta	9.788 m/s ²	Paris	9.809 m/s ²
Chicago	9.803 m/s ²	Rio de Janeiro	9.788 m/s ²
Copenhagen	9.815 m/s ²	Rome	9.803 m/s ²
Cyprus	9.797 m/s ²	San Francisco	9.800 m/s ²
Djakarta	9.781 m/s ²	Singapore	9.781 m/s ²
Frankfurt	9.810 m/s ²	Stockholm	9.818 m/s ²
Glasgow	9.816 m/s ²	Sydney	9.797 m/s ²
Havana	9.788 m/s ²	Tainan	9.788 m/s ²
Helsinki	9.819 m/s ²	Taipei	9.790 m/s ²
Kuwait	9.793 m/s ²	Tokyo	9.798 m/s ²
Lisbon	9.801 m/s ²	Vancouver, BC	9.809 m/s ²
London (Greenwich)	9.812 m/s ²	Washington DC	9.801 m/s ²
Los Angeles	9.796 m/s ²	Wellington NZ	9.803 m/s ²
Madrid	9.800 m/s ²	Zurich	9.807 m/s ²

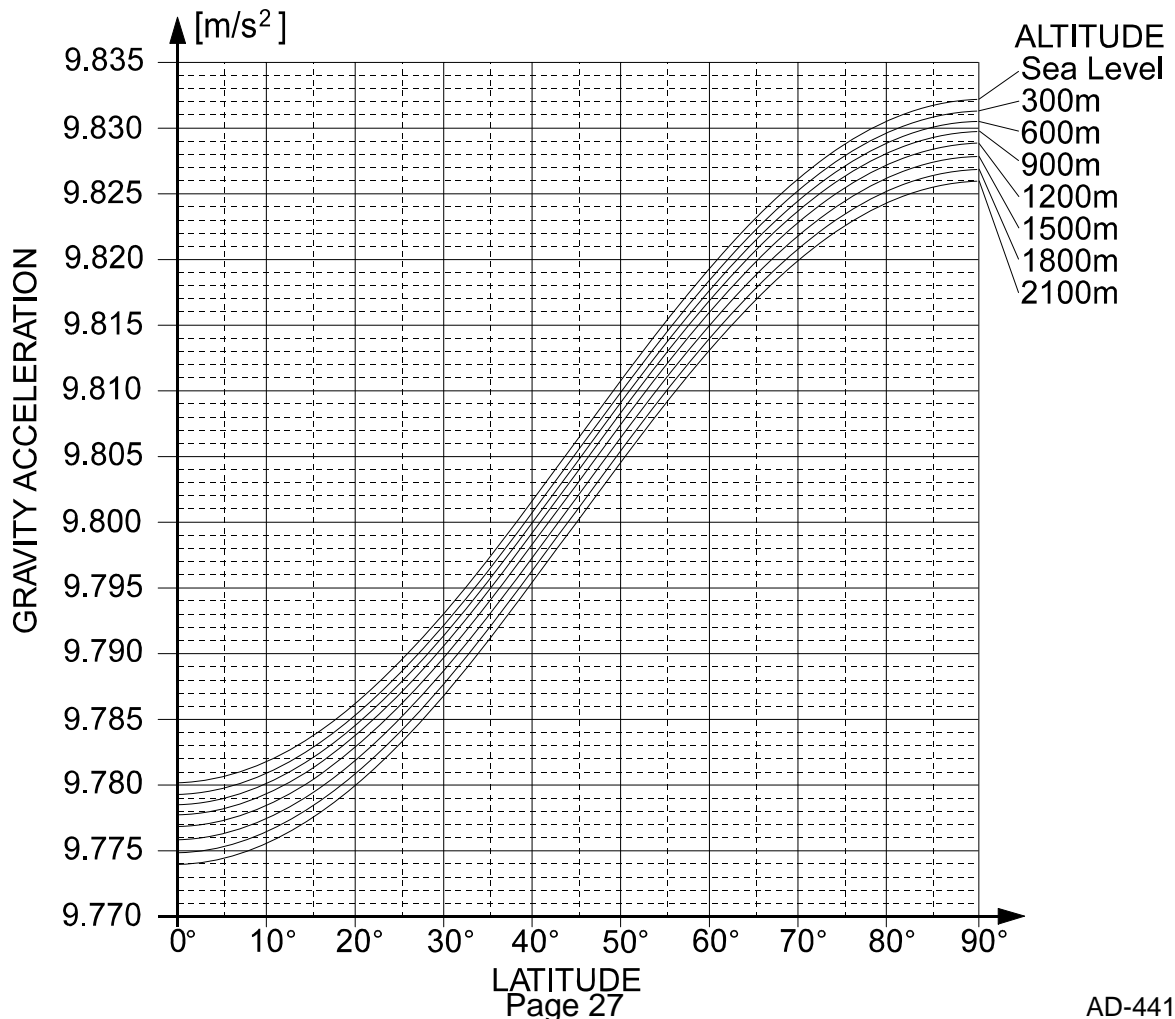

7.5. Digital linearization

Even if zero and span points have been calibrated, weighing errors may occur between the zero point and weighing capacity.

This is a corrective function designed to non-linearly correct weighing errors.

- It is possible to input up to four points in addition to the zero point.
- The zero point and each input point will be corrected to put them in a straight line.
- Areas between input points that could not be corrected completely with straight line correction or with secondary correction will be corrected using a curved line derived from high-order equations.
- When the actual load input for digital linearization is entered in, the calibrated data will be refreshed using zero point and final input point data. There is no need to calibrate again.

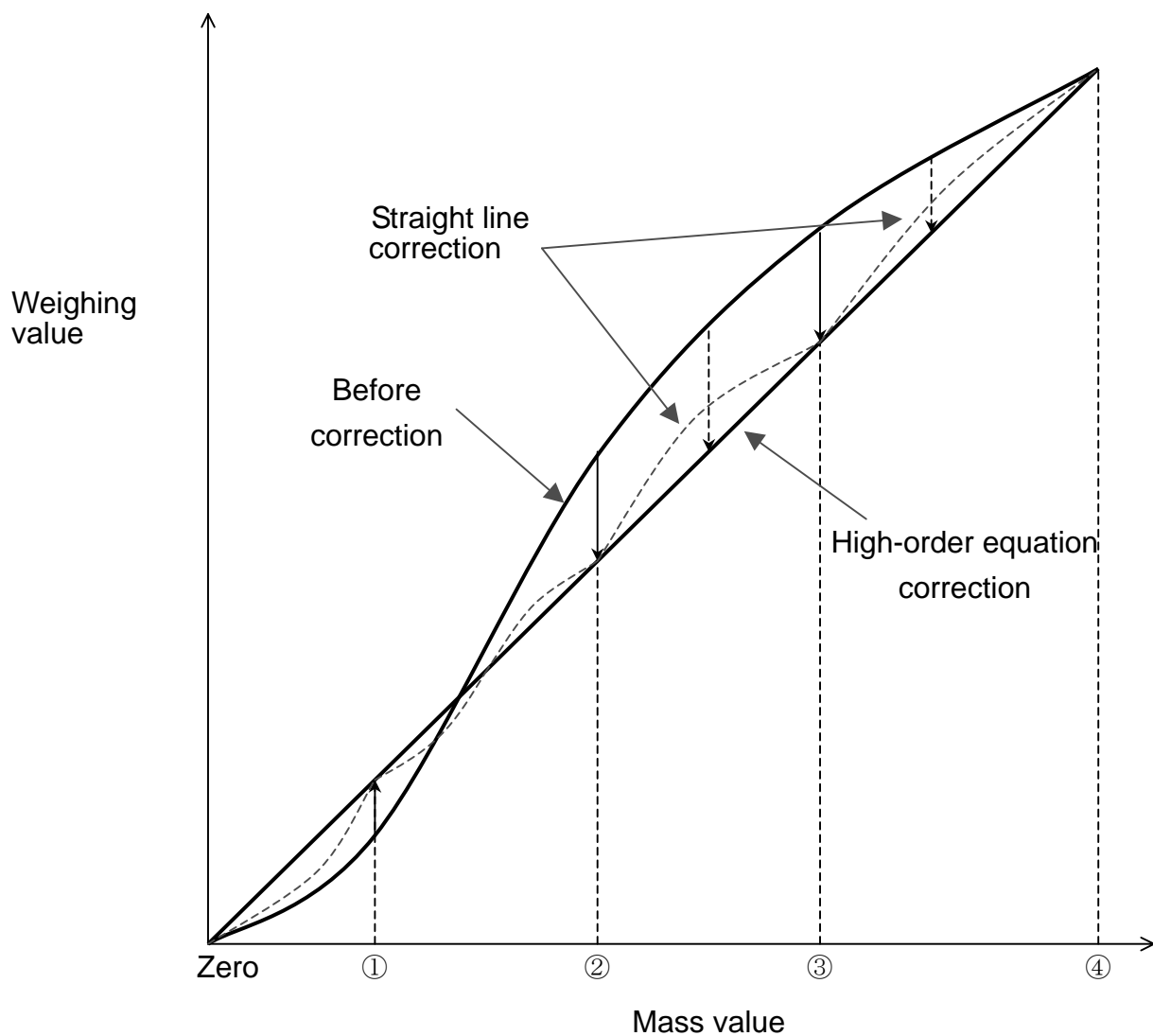

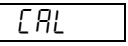



Fig.7 Digital linearization

Actual load setting

Set digital linearization by loading/unloading masses.

* Warm up the instrument for at least ten minutes to avoid the effects of temperature drift.

* The input order should proceed from the smallest mass to the largest mass.

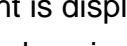
Step 1 Remove the calibration switch cover on the lower left of the front panel, and press the CAL key (the switch inside).  is displayed, meaning the instrument can go into calibration mode. Press the ENTER key to enter into calibration mode, at which point  is displayed. Press the  or  key to select , then press the ENTER key.

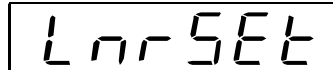
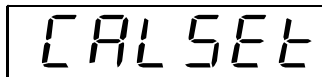
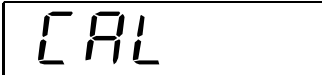

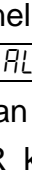

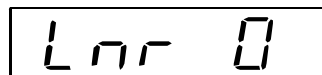
Step 2  is displayed. If you want to monitor the current weighing value, press the CAL key. The gross weight is displayed.





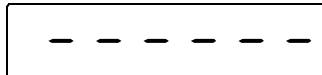

If the CAL key is pressed again,  is displayed.

Step 3 With nothing placed on the load cell, wait for the stabilization indicator to turn ON and then press the ENTER key.  is displayed for two seconds.

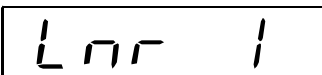

Step 4  is displayed. Press the ENTER key. The mass value is displayed (current weight value setting), and the last digit of the mass value blinks.



Press the     keys to adjust the number to the mass that should be inputted.



If you want to check the current weighing value, press the CAL key. The gross weight is displayed.



If the CAL key is pressed again, the mass value is displayed.

Step 5 Place a calibration weight on the load cell. Wait for the stabilization indicator to turn ON and then press the ENTER key.  is displayed for two seconds.

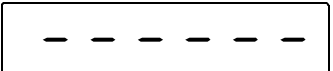

Step 6 Lnr 2 is displayed. Repeat the procedures in Step 4 and Step 5.

Lnr 2

The input steps are as follows:

Lnr 3 → Lnr 4 → Lnr End

Step 7 To finish inputting, proceed to Step 8.

Lnr End

If you want to reenter some settings, press the ▲ or ▼ key to select the input. All data following the reentered data will be cleared.

Step 8 Press the ON/OFF key. Lnr SET is displayed, and the inputted data will be written into the FRAM. At the same time, the calibrated data is also refreshed.

Lnr SET

Press the ON/OFF key again to return to the normal mode.

* If [Err X is displayed, it means some sort of error has occurred.

For details, refer to “7.8 Calibration Errors” to address the issue.

* The blinking of the decimal points indicates that it is not the weighed value.

7.6. Calibration-Related Functions (CALF)

Step 1 Press the ON/OFF key to turn the indicator ON (weighing mode) if it is in the OFF mode.

Remove the CAL key cover and press the CAL key.

CAL is displayed to indicate that the indicator has entered the calibration mode.

Step 2 Press the ENTER key to display **CALSEt**. The indicator enters the mode of calibration with an actual load. To go back to the weighing mode, press the ESC key.

Step 3 Press the \blacktriangle or \blacktriangledown key to select **CALF** and press the ENTER key.

Step 4 Press the \blacktriangle or \blacktriangledown key to select a function number to be used and press the ENTER key. The current setting value is displayed.

Step 5 Change the value as necessary. Two methods to change are available, depending on the function number as below

Method	Description
Selecting a parameter	Only the available parameter is displayed and blinks. Press the \blacktriangle or \blacktriangledown key to select a parameter.
Inputting the value	All the digits are displayed and a digit to be changed blinks. Press the \blacktriangleleft or \blacktriangleright key to select a digit and press the \blacktriangle or \blacktriangledown key to change the value.

After setting, press the ENTER key. The next function number is displayed.

When the value is not to be changed, press the ESC key to return to the function number display.

Step 6 Press the ESC key. **CALF** is displayed and the data of the calibration-related functions is written into the FRAM.

Press the ESC key again to go back to the weighing mode.

NOTE: The blinking decimal point indicates that the current value is not the weight value.

If a value exceeding the settable range is entered, **Err dt is displayed and the input is canceled.**

Function No. Parameter or Setting range	Function	Description	Default value
<i>CALF01</i> 0 to 7	Unit	Unit of the weight value 0: None 1: g 2: kg 3: t 4: N 5: kN 6: lb (U.S.A. version) 7: oz (U.S.A. version)	2
<i>CALF02</i> 0 to 5	Decimal point position	Decimal point position of the weight value 0: None 123456 1: 10 ¹ 12345.6 2: 10 ² 1234.56 3: 10 ³ 123.456 4: 10 ⁴ 12.3456 5: 10 ⁵ 1.23456	0
<i>CALF03</i> 1 to 6	Minimum division	Minimum division (d) of the weight value 1: 1 2: 2 3: 5 4: 10 5: 20 6: 50	1
<i>CALF04</i> 1 to 999999	Weighing capacity	Weighing capacity of the weighing instrument Weighing is possible up to the value of this setting plus 8 d. If the value exceeds this, overflow will occur and will not be displayed. The decimal point position is the same as the setting of <i>CALF02</i> .	70000
<i>CALF05</i> 0 to 100	Zero adjustment range	Range to enable zero adjustment by the ZERO key Expressed as a percentage of the weighing capacity with the calibration zero point as the center. For example, if this is set to 2, the value in the range of ±2% of the weighing capacity with the calibration zero point at the center will be to zero. When a power-ON zero is performed, the initial zero point will be the center.	2

Function No. Parameter or Setting range	Function	Description	Default value
<i>CALF06</i> 0.0 to 5.0	Zero tracking time	Performs zero tracking using this setting in combination with the setting of the zero tracking band. When 0.0, zero tracking will not be performed. Unit: second in 0.1 increments	0.0
<i>CALF07</i> 0.0 to 9.9	Zero tracking band	Performs zero tracking using this setting in combination with the setting of the zero tracking time. When 0.0, zero tracking will not be performed. Unit: d (minimum division) in 0.1 increments	0.0

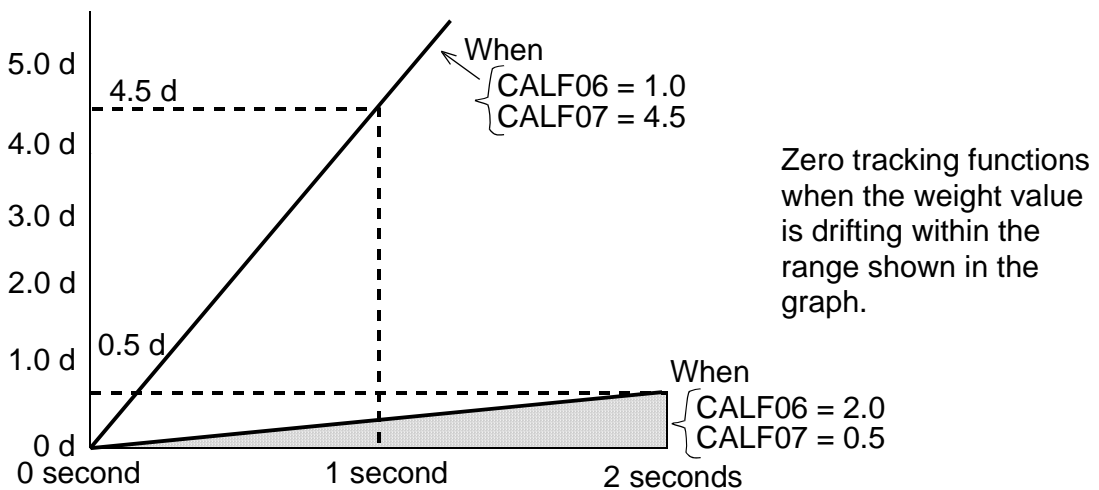
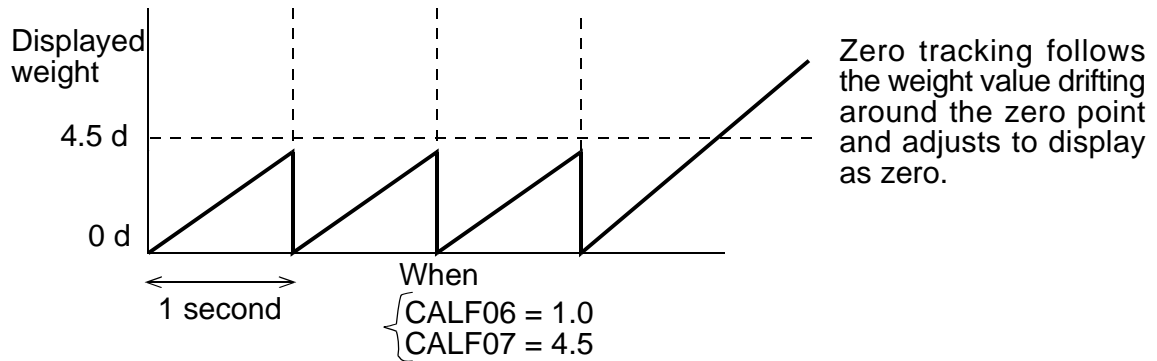

Function No. Parameter or Setting range	Function	Description	Default value
<i>CALF08</i> 00 to 99	Stability detection time	Performs stability detection using this setting in combination with the setting of the stability detection band. When 0.0, stability detection will not be performed. (Stable all the time) Unit: second in 0.1 increments	10
<i>CALF09</i> 0 to 9	Stability detection band	Performs stability detection using this setting in combination with the setting of the stability detection time. When 0, stability detection will not be performed. (Stable all the time) Unit: d (minimum division)	2
<p>Stability detection outputs the STABLE signal when changes in the weight value are within a certain range during a certain time.</p> <p>The graph illustrates the stability detection process. The top part shows the 'Weight value' which rises, then fluctuates within a band defined by CALF09. A horizontal interval CALF08 is shown during this fluctuation. The bottom part shows the 'STABLE signal' which is high during the first fluctuation and low during the second. The STABLE signal is high when the weight value is within the CALF09 band for a duration of CALF08.</p>			
<i>CALF10</i> 0 to 1	Tare and zero adjustment when unstable	Tare and zero adjustment when the weight value is unstable. 0: Disables both functions. 1: Enables both functions.	1
<i>CALF11</i> 0 to 1	Tare when the gross weight is negative	Tare when the gross weight is negative. 0: Disables tare. 1: Enables tare.	1
<i>CALF12</i> 0 to 1	Output when overflow and unstable	Standard serial output when the weight value overflows and is unstable. 0: Disables output. 1: Enables output.	1

Function No. Parameter or Setting range	Function	Description	Default value
<i>CALF 13</i> <i>1 to 3</i>	Exceeding negative gross weight	To judge when the negative gross weight is exceeded. A/D negative exceeded or, <i>1</i> : Gross weight < -999999 <i>2</i> : Gross weight < negative weighing capacity <i>3</i> : Gross weight < -19 d	<i>1</i>
<i>CALF 14</i> <i>1 to 2</i>	Exceeding negative net weight	To judge when the negative net weight is exceeded. Gross weight negative exceeded or, <i>1</i> : Net weight < -999999 <i>2</i> : Net weight < negative weighing capacity	<i>1</i>
<i>CALF 15</i> <i>0 to 1</i>	Clear the zero value	Select whether or not to clear the zero value. <i>0</i> : Disables. <i>1</i> : Enables.	<i>1</i>
<i>CALF 16</i> <i>0 to 1</i>	Zero setting when power is turned on	Select whether or not to perform zero setting when power is turned on. <i>0</i> : Disables. <i>1</i> : Enables.	<i>0</i>
<i>CALF 17</i> <i>-700000 to</i> <i>700000</i>	Input voltage at zero	Input voltage from a load cell at zero. Unit: mV/V This value is determined in zero calibration during the calibration with an actual load.	<i>000000</i>
<i>CALF 18</i> <i>000000 1 to</i> <i>999999</i>	Input voltage at span	Input voltage from a load cell at span Unit in mV/V This value and the value of <i>CALF 19</i> are determined in span calibration during the calibration with an actual load.	<i>320000</i>
<i>CALF 19</i> <i>1 to 999999</i>	Calibration weight value corresponding to Input voltage at span	The calibration weight value corresponding to the Input voltage at span of <i>CALF 18</i> . When performing digital span, <i>CALF 17</i> , <i>18</i> and <i>19</i> are required. The decimal point position is the same as the setting of <i>CALF02</i> .	<i>32000</i>

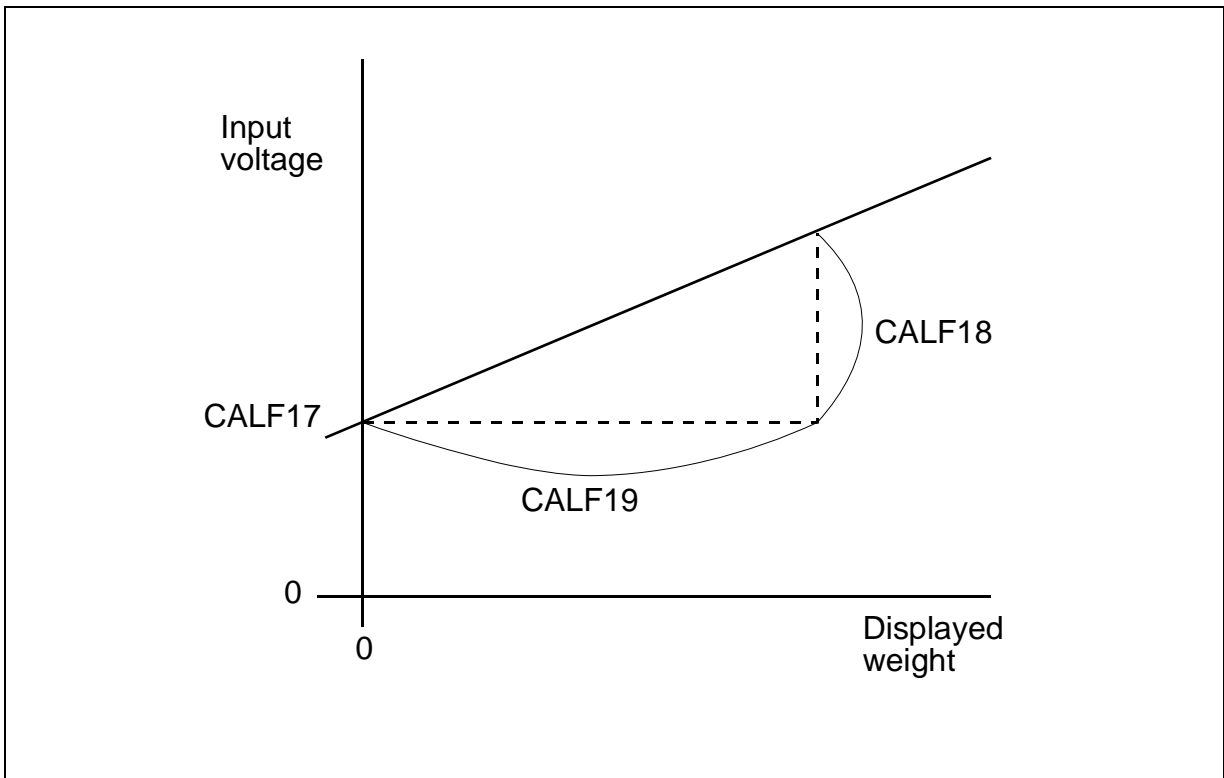

NOTE: Record the setting values of *CALF 17*, *18* and *19* in the “Setting List” at the end of the manual to prepare against a failure.

By changing the parameters of *CALF 17*, *18* and *19*, “zero calibration” and “span calibration” can be adjusted optionally. (Digital span accuracy approx. 1/5000: The accuracy varies depending on the load cell output accuracy and the conditions of calibration.)

Except for an emergency, perform calibration with an actual load.

<i>CALF20</i> 0 to 1	Output when the gross weight is negative	Output by the manual print command when the gross weight is negative. 0: Enables output. 1: Disables output.	0
<i>CALF21</i> 0 to 1	Communication restriction	Restriction on network-related communication such as changing station numbers or ID numbers and outputting by auto printing 0: Disables restriction. 1: Enables restriction.	0
<i>CALF22</i> 1 to 2	Header 2	Second header of serial output 1: GS/NT/TR 2: G_/N_/T_ (_ is space, ASCII 20h)	1
<i>CALF23</i> 1 to 2	Number of digits for unit in serial output data	1: 2 digits 2: 3 digits	1
<i>CALF24</i> 1 to 6	Scale interval of dual range	Minimum division (d) of second range 1: 1 2: 2	1

		<p>3: 5 4: 10 5: 20 6: 50</p> <p>If this is set to less than the scale interval of Range 1, the instrument will revert to single range mode. The scale interval for Range 1 is <i>CALF03</i>.</p>	
<p><i>CALF25</i> 0 to 999999</p>	Dual range border	<p>When the absolute weighing value (gross weight or net weight) is over the set range, it will become Range 2. The weighing capacity for Range 2 is <i>CALF04</i>. The decimal point position is linked to <i>CALF02</i>.</p>	0
<p><i>CALF26</i> 9.75000 to 985000</p>	Gravity acceleration of place of calibration	<p>Gravity acceleration of the place of calibration. Units in m/s²</p>	980000
<p><i>CALF27</i> 9.75000 to 985000</p>	Gravity acceleration of place of use	<p>Gravity acceleration of the place where the scale is being used. Units in m/s²</p>	980000
<p><i>CALF28</i> 0 to 1</p>	Disable averaging hold	<p>0: Enabled 1: Disabled</p>	0

7.7. Linearity-related functions (LnrFnc)

Confirm and change linearity settings.

To use this function, select “*LnrF*” in the same way as calibration-related functions are selected.

Function No. Parameter or Setting range	Function	Description	Default value
<i>LnrF01</i> 0 to 5	Number of input points	Number of points where linear input was done. The linear-zero input is included as one point. Digital linearization is not performed when the set value is between 0 and 2.	0
<i>LnrF02</i> - 700000 to 700000	Linear-zero	Voltage during linear-zero input Units in mV/V.	000000
<i>LnrF03</i> 0 to 999999	Linear 1 mass value	The mass value during linear 1 input The decimal point position depends on <i>CALF02</i> .	0
<i>LnrF04</i> 000000 to 999999	Linear 1 span	The span voltage from linear-zero during linear 1 input Units in mV/V.	000000
<i>LnrF05</i> 0 to 999999	Linear 2 mass value	The mass value during linear 2 input The decimal point position depends on <i>CALF02</i> .	0
<i>LnrF06</i> 000000 to 999999	Linear 2 span	The span voltage from linearity zero during linearity 2 input Units in mV/V.	000000
<i>LnrF07</i> 0 to 999999	Linear 3 mass value	The mass value during linear 3 input The decimal point position depends on <i>CALF02</i> .	0
<i>LnrF08</i> 000000 to 999999	Linear 3 span	The span voltage from linearity zero during linearity 3 input Units in mV/V.	000000
<i>LnrF09</i> 0 to 999999	Linear 4 mass value	The mass value during linear 4 input The decimal point position depends on <i>CALF02</i> .	0
<i>LnrF10</i> 000000 to 999999	Linear 4 span	The span voltage from linearity zero during linearity 4 input Units in mV/V.	000000

7.8. Calibration Errors

When an error occurs during calibration, the error number is displayed.

If calibration is finished without removing the error, the setting values will be restored to the state before calibration.

Calibration errors and remedies

Error No.	Description	Remedy
[Err 1	The display resolution (weighing capacity / minimum division) exceeds the specified value.	Make the minimum division greater or make the weighing capacity smaller. The specified value depends on the instrument or specifications.
[Err 2	Voltage at zero calibration exceeds in the positive direction.	Check the load cell rating and connection. When nothing is wrong with the rating and connection, adjust the load cell output as described in the next section. When the load cell or A/D converter may be the cause of error, confirm this by using the check mode.
[Err 3	Voltage at zero calibration exceeds in the negative direction.	
[Err 4	The value of the calibration weight exceeds the weighing capacity.	Use an appropriate calibration weight and calibrate again.
[Err 5	The value of the calibration weight is less than the minimum division.	
[Err 6	The load cell sensitivity is not sufficient.	Use a load cell with higher sensitivity or make the minimum division greater.
[Err 7	Voltage at span calibration is less than voltage at the zero point.	Check the load cell connection.
[Err 8	The load cell output voltage is too high when the load of the weighing capacity is placed.	Use a load cell with a greater rating or make the weighing capacity smaller.

7.9. Load Cell Output Adjustment

Add a resistor as shown below to adjust the load cell output.

Use a resistor with a high resistance value and a low temperature coefficient.

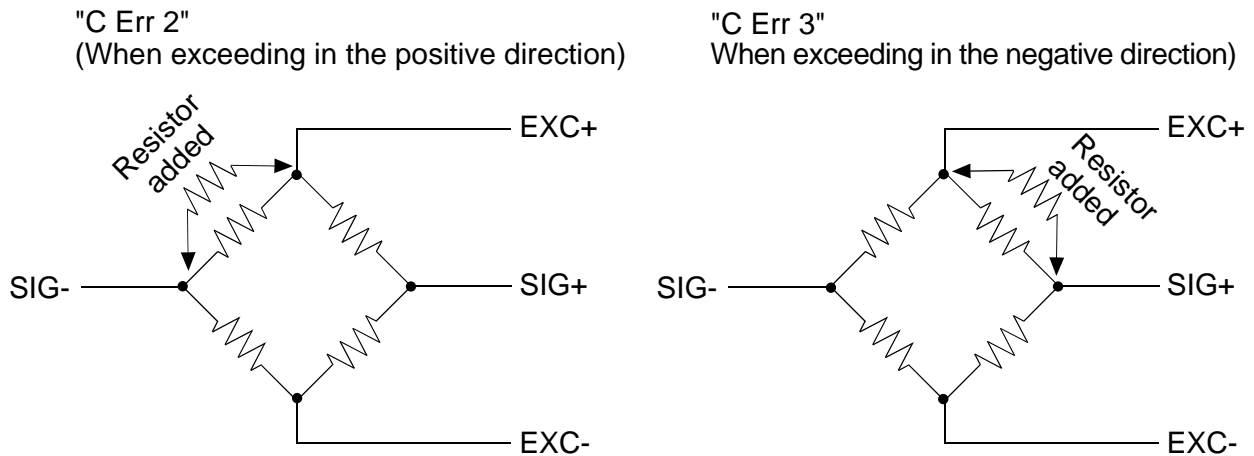

Fig.8 Load cell output adjustment

* Because the zero point of the AD-4410 has a wide adjustable range, as long as there is no problem with a load cell, correcting an output by the AD-4410 is hardly ever required.

Before an output correction is carried out, confirm load cells (deformation, wiring mistakes, contact with anything, or model selection etc.) and connections.



8. General Functions

General functions are divided into groups according to function and are indicated by the group name with the function number.

NOTE: General functions determine the AD-4410 performance and all of the settings are stored in the FRAM.

8.1. Setting Procedure

Step 1 While pressing and holding the ENTER key, press the F key.

F_{nc} is displayed to indicate that the indicator will enter the general function mode.

Step 2 Press the ENTER key. The indicator enters the general function mode.

To go back to the weighing mode without entering the general function mode, press the ESC key.

Step 3 Press the \uparrow or \downarrow key to select the function group to be set.

Display	Group name
$F_{nc}F$	Basic functions
$HLdF$	Hold functions
$io F$	Control I/O
$[L F$	Standard serial output
$r5 IF$	RS-232C (Standard)
$r52F$	RS-232C (ch2) / RS-485

Press the ENTER key. The function number will be displayed.

Step 4 Press the \uparrow or \downarrow key to select the function number to be set.

Press the ENTER key. The current setting value will be displayed.

Step 5 Change the setting value using either one of the methods below.

Method	Description
Selecting a parameter	Only the parameter number to be selected is displayed and blinks. Press the \uparrow or \downarrow key to select a parameter.
Inputting the value	All the digits are displayed and the digit to be changed blinks. Press the \leftarrow or \rightarrow key to select a digit and press the \uparrow or \downarrow key to change the value.

After setting, press the ENTER key. The next function number is displayed.

When the parameter is not to be changed, press the ESC key to return to the function number display.

- Step 6 Press the ESC key. The function number disappears and the indicator returns to the state of step 3.
Press the ESC key to store the setting values in the FRAM and go back to the weighing mode.

NOTE: The blinking decimal point indicates that the current value is not the weight value.

If a value exceeding the settable range is entered, Err dt is displayed and the input is canceled.

8.2. Adjusting the digital filter

Adjust the digital filter using $FncF05$ (digital filter).

The available settable range for the cutoff frequency is from 11 Hz to 0.07 Hz.

The cut off frequency is the frequency where vibrations begin to decline.

1. If the weighing value is unstable, set the cutoff frequency lower.
2. To make the response faster, set the cutoff frequency higher.

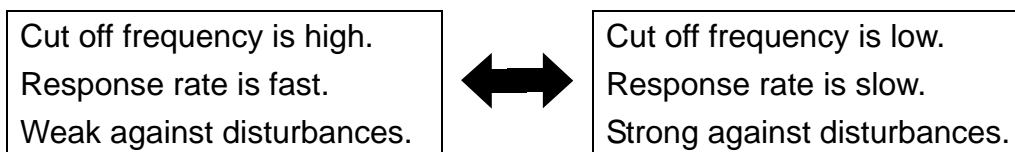





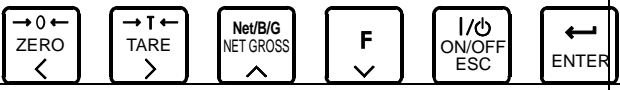

* It is possible to make adjustments while watching the effects of the digital filter with your own eyes.

By pressing the CAL key while setting $FncF05$ (digital filter), it is possible to check the weight displayed.

- | | |
|--|--------------------------------------|
| ZERO key | Set the display to zero. |
| ▲ Key | Increase stability. |
| ▼ Key | Increase speed. |
| CAL key | Return to the value setting display. |

8.3. Basic Functions (FnCF)

Function No. Parameter range	Function	Description	Default value
<i>FncF01</i> 000000 to 111111	Disable key switch	Each digit of the setting corresponds to a key switch. Only available in the weighing mode. 0: Does not disable the key switch function. 1: Disables the key switch function. Key assignment to each binary digit <div style="display: flex; justify-content: space-around; text-align: center;"> <div>6th </div> <div>5th </div> <div>4th </div> <div>3rd </div> <div>2nd </div> <div>1st </div> </div>	000000 (binary)
<i>FncF02</i> 0 to 6	F key	Assigns a function to the F key. 0: None 1: Manual print command 2: Hold 3: Alternate switch 4: Momentary switch 5: Clear the tare weight 6: Clear the zero value NOTE: Clearing the zero value can be enabled or disabled by <i>CALF 15</i>	0
<i>FncF03</i> 1 to 3	Display update rate	1: 20 times/second 2: 10 times/second 3: 5 times/second	1
<i>FncF04</i> 0 to 13	□ display	Assigns a function to the □ display. 0: None 1: Zero tracking in progress 2: Alarm (Zero range setting error, over) 3: F key status 4: Near zero 5: HI output (Over the upper limit value) 6: OK output (Within upper and lower limit values) 7: LO output (Below the lower limit value) 8: User input 1 9: User input 2 10: User input 3 11: User output 1 12: User output 2 13: User output 3	0
<i>FncF05</i> 0 to 6	Digital filter	Selects a cutoff frequency. 0: None 1: 11.0 Hz 2: 8.0 Hz 3: 5.6 Hz 4: 4.0 Hz 5: 2.8 Hz 6: 2.0 Hz	8

		<p>7: 1.4 Hz 8: 1.0 Hz 9: 0.7 Hz 10: 0.5 Hz 11: 0.33 Hz 12: 0.25 Hz 13: 0.17 Hz 14: 0.13 Hz 15: 0.10 Hz 16: 0.07 Hz</p>	
<i>FncF07</i> 1 to 3	Hold	<p>1: Normal hold 2: Peak hold 3: Averaging hold</p>	1
<i>FncF08</i> -999999 to 999999	Set value of near-zero	The reference value for near-zero Decimal point position is linked to <i>CALF02</i> .	10
<i>FncF09</i> 1 to 2	Mass to be compared with near-zero	Item to be compared with near-zero <p>1: Gross weight 2: Net weight</p>	1
<i>FncF10</i> -999999 to 999999	Set value of upper limit	Reference value for the upper limit The decimal point position is linked to <i>CALF02</i> .	10
<i>FncF11</i> -999999 to 999999	Set value of lower limit	Reference value for the lower limit The decimal point position is linked to <i>CALF02</i> .	- 10
<i>FncF12</i> 1 to 2	Mass to be compared with upper and lower limit	Item to be compared with the upper and lower limit <p>1: Gross weight 2: Net weight</p>	1
<i>FncF13</i> 1 to 2	Output logic of upper and lower limit	Logic used when the result of the comparison with the upper and lower limit is output <p>1: Positive logic 2: Negative logic</p>	1

8.4. Hold

Function No. Parameter range	Function	Description	Default value
<i>HLdF01</i> 0.00 to 9.99	Averaging time	Time to perform the averaging. Units in seconds. 0.00 is not averaged.	0.00
<i>HLdF02</i> 0.00 to 9.99	Start wait time	Time to wait before commencing hold or averaging. Units in seconds.	0.00
<i>HLdF03</i> 0 to 2	Condition of automatic start	Condition to start the hold or averaging automatically 0: Do not use automatic start. 1: Above the near-zero range, and stable 2: Above the near-zero range	0
<i>HLdF04</i> 0 to 1	Release due to falling control input	Release when control input is falling 0: Do not release 1: Release	1
<i>HLdF05</i> 0.00 to 9.99	Time release	Release after a set amount of time has passed Units in seconds. Release will not happen if the value is set to 0.00.	0.00
<i>HLdF06</i> 0 to 999999	Release due to range of fluctuation	Release when fluctuation from the holding value exceeds a set value The decimal point position is linked to <i>CALF02</i> . Release will not happen if the value is set to 0.	0
<i>HLdF07</i> 0 to 1	Release in near-zero range	Release when the weighing value is in the near-zero range 0: Do not release 1: Release	0

* This hold function only works when *FncF07* (hold) is set to 2 (peak hold) or 3 (averaging hold). This hold function has no function when *FncF07* (hold) is set to 1 (normal hold).

* *HLdF01* (averaging time) works only when *FncF07* (hold) is set to 3 (averaging hold).

* *HLdF04* Release when control input is falling

0: Do not release

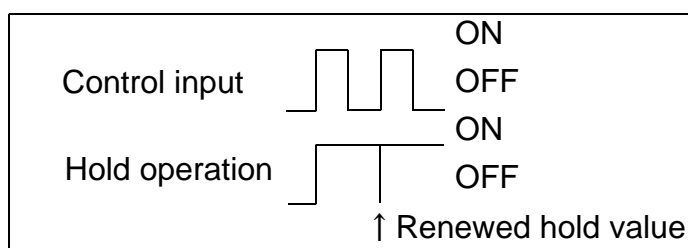

When not releasing at falling control input, release condition is set by *HLdF05* to 07.

/: Release (Initial value)

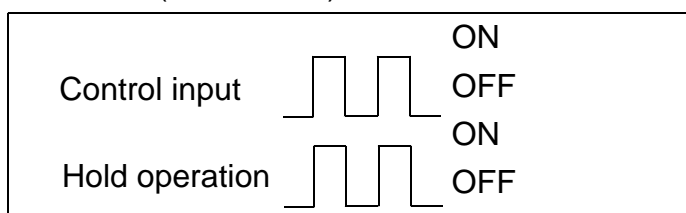

8.5. Control I/O

Function No. Parameter or Setting range	Function	Description	Default value
<i>10 F01</i> 0 to 13	Control input 1	0: None 1: Zero 2: Clear zero 3: Tare 4: Clear tare 5: Gross weight display 6: Net weight display 7: Changing between gross weight and net weight 8: Hold 9: Print command 10: key 11: User input 1 12: User input 2 13: User input 3	1
<i>10 F02</i> 0 to 13	Control input 2		3
<i>10 F03</i> 0 to 13	Control input 3		7
<i>10 F04</i> 0 to 18	Control output 1	0: None 1: Stabilization 2: While displaying gross weight 3: While displaying net weight 4: During tare 5: Near zero 6: During hold 7: Hold busy state 8: HI output (Over upper limit) 9: OK output (Within upper and lower limits) 10: LO output (Under lower limit) 11: User output 1 12: User output 2 13: User output 3 14: During operating weighing (On) 15: During operating weighing (1 Hz) 16: During operating weighing (50 Hz) 17: Zero correction error 18: Tare error	3
<i>10 F05</i> 0 to 18	Control output 2		4
<i>10 F06</i> 0 to 18	Control output 3		5

* User input is a function to enable status confirmation by connecting a sensor or switch externally to the AD-4410.

User output is a function to enable controlling using solenoid valves or relays, etc. connected to the AD-4410 externally.

Status of the user input and user output can be confirmed and changed by Modbus or commands using the RS-232C or RS-485.

8.6. Standard Serial (current loop)

Function No. Parameter or Setting range	Function	Description	Default value
<i>CL F01</i> 1 to 5	Output data	1: Displayed weight 2: Gross weight 3: Net weight 4: Tare weight 5: Gross/Net/Tare	1
<i>CL F02</i> 1 to 3	Data transfer mode	1: Stream 2: Auto printing ^(Note 1) 3: Manual printing	1
<i>CL F03</i> 1 to 2	Baud rate	1: 600 bps 2: 2400 bps	2
<i>CL F04</i> 0 to 99	ID number	Adds an ID number to the standard serial output. ^(Note 2) 0: Does not add an ID number. 1: 99:	0

NOTE: When “1: Enables restriction” is selected for *CLF21* (Communication restriction):

(Note 1) Auto printing will not be performed even if auto printing conditions are met.

(Note 2) ID numbers can not be changed.

8.7. RS-232C (Standard) / RS-232C (ch2) / RS-485

Function No. Parameter or Setting range	Function	Description	Default value
$r51F01$ $r52F01$ 1 to 5	Output data	1: Displayed weight 2: Gross weight 3: Net weight 4: Tare weight 5: Gross / Net / Tare When the data transfer mode is set to jet stream, 5: will output the load cell output signal in units of 0.00001mV/V.	1
$r51F02$ $r52F02$ 1 to 6	Data transfer mode	1: Stream (Every time display is refreshed) 2: Auto print 3: Manual print 4: Jet stream (Every sampling) 5: Command 6: Modbus-RTU	1
$r51F03$ $r52F03$ 1 to 7	Baud rate	1: 600bps 2: 1200bps 3: 2400bps 4: 4800bps 5: 9600bps 6: 19200bps 7: 38400bps	3
$r51F04$ $r52F04$ 0 to 2	Parity of number of data bits	0: 8-bit data, no parity 1: 7-bit data, odd parity 2: 7-bit data, even parity	2
$r51F05$ $r52F05$ 1 to 2	Terminator	1: CR, LF 2: CR	1
$r51F06$ $r52F06$ 0 to 99	ID number	0: None 1 to 99	0
$r51F07$ $r52F07$ 1 to 2	Decimal point/ Delimiter	1: Decimal point: dot / Delimiter: comma 2: Decimal point: comma / Delimiter: semicolon	1
$r51F08$ $r52F08$ 0 to 1	Time out	1: No limit 2: Approx. 1 second	1
$r51F09$ $r52F09$ 0 to 4	Delay when outputting repeatedly	0: No delay 1: Approx. 0.5 second 2: Approx. 1.0 second 3: Approx. 1.5 second 4: Approx. 2.0 second	0
$r52F10$ 0 to 1	Internal terminating resistance	0: Off 1: On (120Ω) Available only when using RS-485	0



9. Interface

9.1. Control I/O

- Display and data output can be controlled externally using control input.
- Weighing states and results can be output to external devices using control output.
- User input is a function to enable status confirmation by connecting a sensor or switch externally to the AD-4410.

User output is a function to enable controlling using solenoid valves or relays, etc. connected to the AD-4410 externally.

Status of the user input and user output can be confirmed and changed by Modbus or commands using the RS-232C or RS-485.

9.1.1. Specification

Input circuit method	DC input (Source type)
Input terminal open voltage	Approx. 5V
Input circuit driving current	5mA (Maximum)
Allowable residual voltage	2V (Maximum)
Output circuit method	Open collector output
Output circuit pressure-resistance	DC40V
Allowable driving current	50mA
Output terminal residual voltage	1.5V (When driving current is 50mA)

9.1.2. Connection

Function	Pin No.	Signal name	Description
Control input	7	IN1	Control input 1
	5	IN2	Control input 2
	3	IN3	Control input 3
	2	COM (in)	Common terminal of control input
Control output	6	OUT1	Control output 1
	4	OUT2	Control output 2
	1	OUT3	Control output 3
	8	COM (out)	Common terminal of control output
	Shell	FG	Earth

* Total wiring length should be less than 30m and wired indoors.

Adaptive connector JA-TCP0586 (provided)

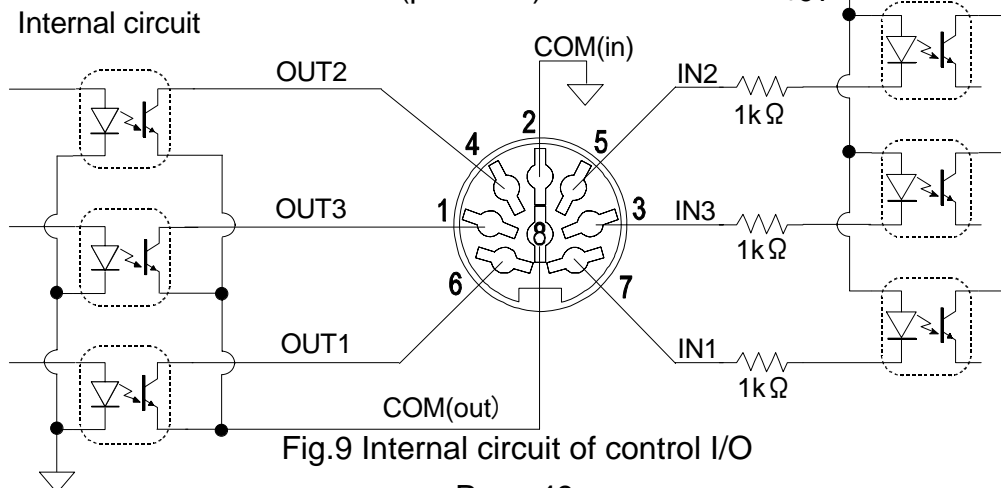

9.2. Serial interface

9.2.1. Standard serial output (Current loop)

AD-4410 has standard serial output (Current loop) and RS-232C (ch1) as standard equipment. Also, it is possible to change the current loop to RS-485 or RS-232C (ch2) for optional units.

AD4410-03 RS-485

AD4410-04 RS-232C (ch2)

* It is impossible to use the current loop when options are connected.

Connection

Pin No.	Signal name	Direction	Description
3	C.L.	Output	Current loop output (No polarity)
5	C.L.	Output	Current loop output (No polarity)
1,2,4,6,7			No use (No connection)
Shell	FG		Shield

* Use a shielded cable when wiring.

C.L./OP internal circuit

Adaptive connector AX-TCP0576-S (provided)

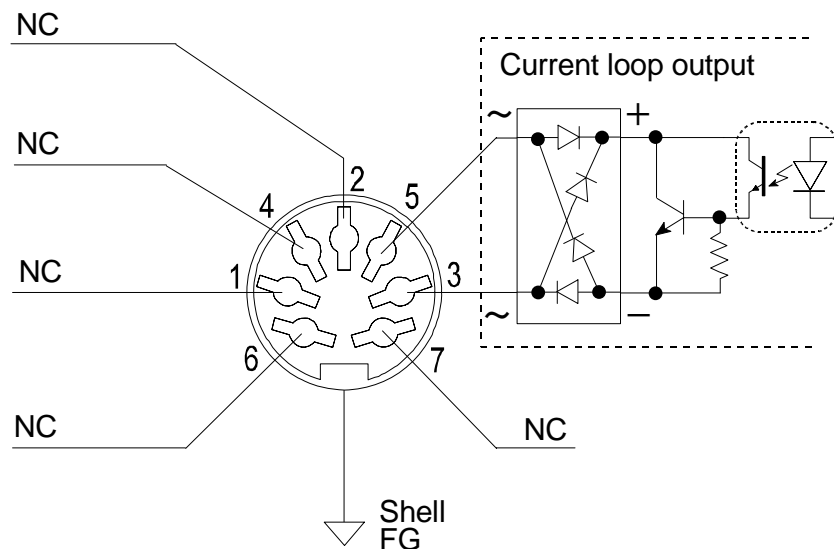

Fig.10 Internal circuit of standard serial output (Current loop)

9.2.2. RS-232C (ch1)

Transmission type : Start-stop synchronous, bi-directional, half duplex
 Baud rate : 600, 1200, 2400, 4800, 9600, 19200, 38400 bps
 Data bits : 7 or 8 bits
 Parity : 1 bit, Even or Odd (Data bits 7 bits)
 None (Data bits 8 bits)
 Start bit : 1 bit
 Stop bit : 1 bit
 Code : ASCII
 Terminator : CR LF, OR (CR:0Dh, LF: 0Ah)
 Connector : D-sub 9 pin male

* Use the straight cable when connecting the AD-4410 to a PC or PLC.

Connection

Pin No.	Signal name	Direction	Description
2	TXD	Output	Transmission data
3	RXD	Input	Received data
5	SG	-	Signal ground
7	RTS	-	7 pin and 8 pin are connected internally.
8	CTS		
1,4,6,9			Not used (No connection)
Shell			Shield

* Total wiring length should be less than 30m and wired indoors.

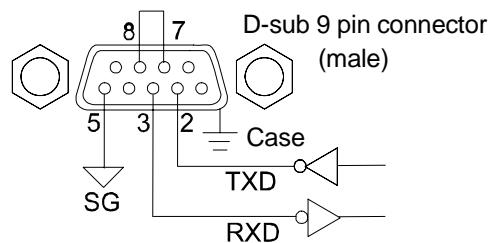

Fig.11 Standard serial output internal circuit (RS-232C)

9.2.3. RS-485 (AD4410-03)

Optionally installed on the AD-4410.

Signal form : EIA RS-485 compliant
 Baud rate : 600, 1200, 2400, 4800, 9600, 19200, 38400 bps
 Data bits : 7 or 8 bits
 Parity : 1 bit, Even or Odd (Data bits 7 bits)
 None (Data bits 8 bits)
 Start bit : 1 bit
 Stop bit : 1 bit
 Signal wire : Twin wires method
 Drop number : Up to 32
 Terminator resistor : 120 Ω (Can select internal connection)
 Character code : ASCII, JIS 8
 Connector : 7 pin DIN connector

Connection

Pin No.	Signal name	Direction	Description
1	A	I/O	Transmission data
2	B	I/O	Received data
4	SG	-	Signal ground
6,7			Not used (No connection)
3,5			Current loop output
Shell	FG	-	Shield

- * By setting the function, setting the terminator resistance (120 Ω) to be available or unavailable is possible.
- * Use a shielded cable when wiring.
- * Do not connect to the current loop output.
- * Depending on the model, the A and B terminals of the RS-485 may be reversed.
- * When there is no signal ground for the RS-485, there is no need to wire the SG terminal
- * Connect to the FG terminal when a shield connection is required.

C.L./OP internal circuit

Adaptive connector AX-TCP0576-S (provided)

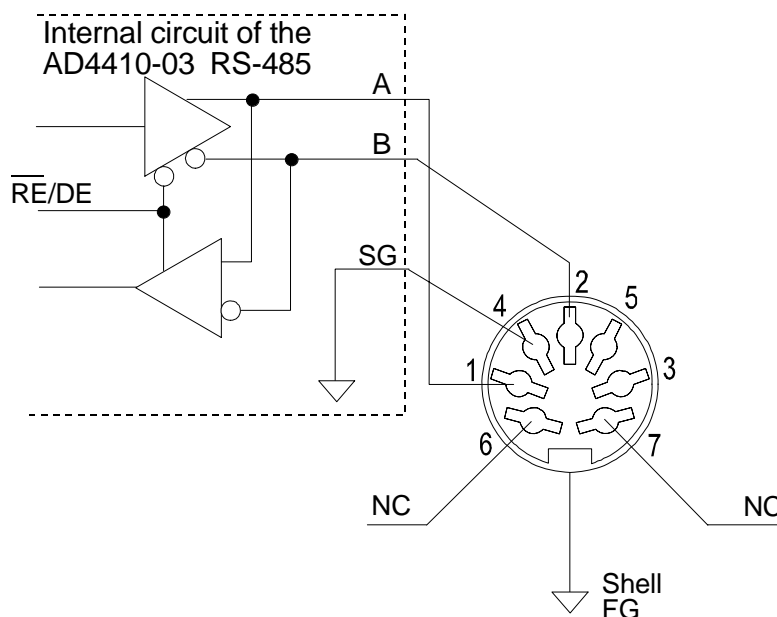

Fig.12 Option internal circuitry (AD4410-03)

9.2.4. RS-232C (AD4410-04) (ch2)

Optionally installed on the AD-4410.

Transmission form : Start-stop synchronous, bi-directional, half duplex
 Baud rate : 600, 1200, 2400, 4800, 9600, 19200, 38400 bps
 Data bits : 7 or 8 bits
 Parity : 1 bit, Even or Odd (Data bits 7 bits)
 None (Data bits 8 bits)
 Start bit : 1 bit
 Stop bit : 1 bit
 Code : ASCII
 Terminator : CR LF, OR (CR:0Dh, LF: 0Ah)
 Connector : 7-pin DIN connector

Connection

Pin No.	Signal name	Direction	Description
1	TXD	Output	Transmission data
2	RXD	Input	Received data
4	SG	-	Signal ground
6	DSR	Output	
7			Not used (No connection)
3,5			Current loop output
Shell	FG	-	Shield

- * Do not connect to the current loop output.
- * Connect the RTS and CTS by a cable side.
- * Total wiring length should be less than 30m and wired indoors.

C.L./OP internal circuit

Adaptive connector AX-TCP0576-S (provided)

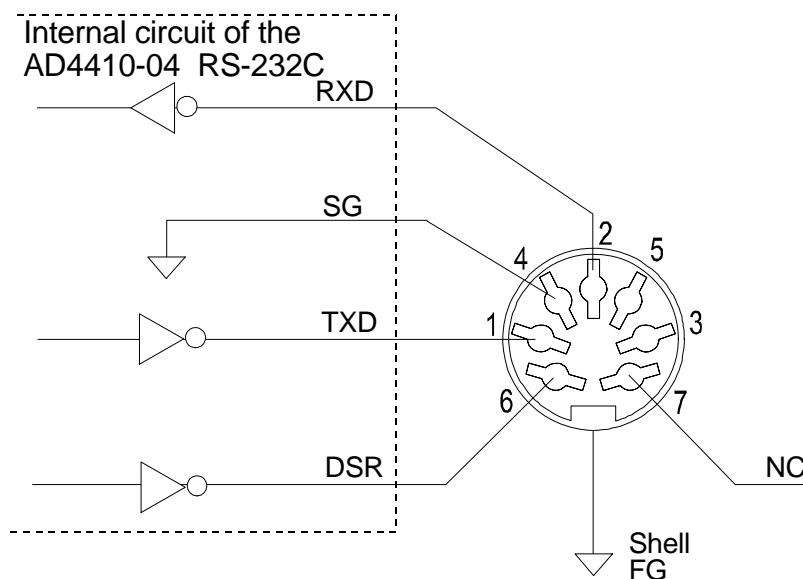
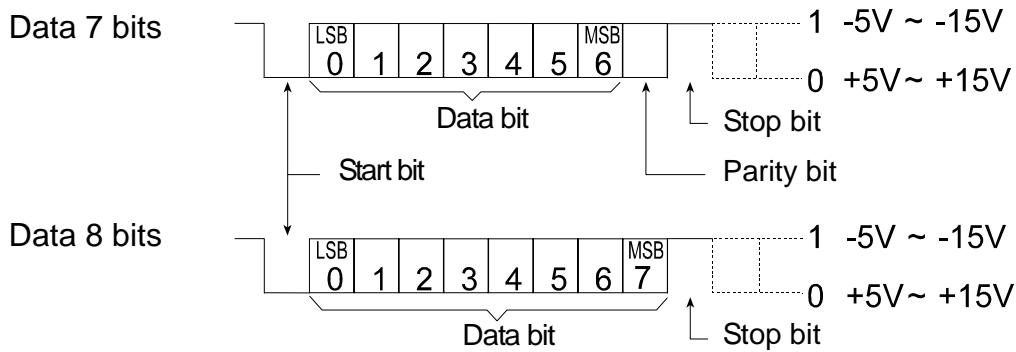

Fig.13 Option internal circuitry (AD4410-04)

9.2.5. Bit structure



9.2.6. Data transfer mode

Six data transfer modes are available; stream, auto printing, manual printing, jet stream, command or Modbus-RTU. When using the built-in serial output (Standard), three data transfer modes are available; stream, auto printing or manual printing.

Stream mode	Transmits data in sync with the display update rate. If the indicator can not catch up with the update rate because of the baud rate, the transmission is paused until the next updating. The transmitted data is the same as what is being displayed. Data that is not displayed is never transmitted.
Auto printing mode	Transmits data one time once a weight value of 5 d or greater has stabilized. For a further transmission, the weight value must fall below 5 d and then stabilize again above that value.
Manual printing mode	Transmits data when the F key, assigned as the manual print command, is pressed.
Jet stream mode	Transmits data in sync with the sampling rate. If the indicator can not catch up with the sampling because of the baud rate, the transmission is paused until the next sampling.
Command mode	When carrying out a command, it returns the received command or response data.
Modbus-RTU mode	The interface can be used as slave device of Modbus RTU. When using Modbus RTU interface installed in the AD-4410, the master device can read measurement value and status information and store parameters to the AD-4410. The interface can be connected easily to computer, PLC (Sequencer) and programmable display adapted to the Modbus RTU. The built-in RS-232C (Standard), option RS-232C (OP-04) and RS-485 (OP-03) can be used for the interface and protocols.

Functions related to the data transfer mode

- Set `[L F04, r5 IF06` or `r52F06` (ID number) to add an ID number to standard serial output.

Example:

`@ 0 9 S T , G S , + 0 1 2 3 . 4 5 k g CR LF`
 ID number

- Set `[ALF20` (disables negative output) to disable the print command when gross weight is negative.

- Set `[ALF22` (header 2) to change header 2 to G, N or T.

9.2.7. Data format

The data format used is A&D standard format or jet stream format.

A&D standard format

This is the format to be used with an A&D printer or remote display and consists of two headers, data, unit and a terminator.

`S T , G S , + 0 1 2 3 . 4 5 k g CR LF`
 Header 1 Header 2 Data Unit Terminator
 (8-digit with a polarity and a decimal point)

	ASCII code	Hexadecimal	Description
Header 1	ST	[53 54]	Stable
	US	[55 53]	Unstable
	OL	[4F 4C]	Overload
	HD	[48 44]	Hold
Header 2	GS	[47 53]	Gross weight
	NT	[4E 54]	Net weight
	TR	[54 52]	Tare weight
Separator	,	[2C]	
Data (ASCII code)	0 to 9	[30 to 39]	
	+	[2B]	
	-	[2D]	
	SP (space)	[20]	
	. (period)	[2E]	
Unit (six types)	SP SP	[20 20]	No unit
	SP g	[20 67]	g
	kg	[6B 67]	kg
	SP t	[20 74]	t
	SP N	[20 4E]	N
	k N	[6B 4E]	kN
Terminator	CR	[0D]	
	LF	[0A]	

A&D standard format examples

	Header 1	Header 2	Data (8-digit with a polarity and a decimal point)	Unit	Terminator	
Gross weight	S T ,	G S ,	+ 0 0 1 2 3 4 5	k g	C _R L _F	Header 2 [GS]
Net weight	S T ,	N T ,	+ 0 0 1 0 0 0 0	k g	C _R L _F	Header 2 [NT]
Tare weight	S T ,	T R ,	+ 0 0 0 2 3 4 5	k g	C _R L _F	Header 2 [TR]
Data with a decimal point	S T ,	G S ,	+ 0 1 2 3 . 4 5	k g	C _R L _F	Data [.]
Positive overflow	O L ,	G S ,	+ SP SP SP SP . SP SP	k g	C _R L _F	Header 1 [OL]
Negative overflow	O L ,	G S ,	- SP SP SP SP . SP SP	k g	C _R L _F	Header 1 [OL] Polarity [-]
Unstable data	U S ,	G S ,	+ 0 1 2 3 . 4 5	k g	C _R L _F	Header 1 [US]
“Output OFF” data	O L ,	G S ,	+ SP SP SP SP . SP SP	k g	C _R L _F	Same as positive overflow

NOTE: The decimal point position is the same even when overflow occurs.

Jet stream format

This is the format for jet stream mode, which has no headers, decimal points, or units to maintain high-speed output.

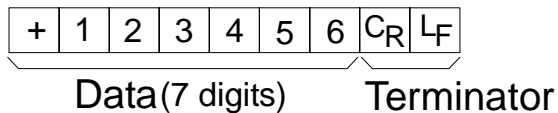

	ASCII code	Hexadecimal	Description
Data (ASCII code)	0 to 9	[30 to 39]	
	+	[2B]	
	-	[2D]	
	SP (space)	[20]	
Terminator	CR	[0D]	
	LF	[0A]	

9.2.8 Command and response

Any data transfer mode can be used, but responses are not carried out in the stream and jet stream mode.

The indicator returns “?” when the command can not be read, or it returns “I” when the command can not be carried out.

Add “@NN” (NN is number set by function.) ahead of command when adding the ID number. Command is not carried out when there is no “@NN” or the number is wrong. “@NN” is also added ahead of the response.

9.2.8.1 Commands to output data

Display data request

Outputs display data immediately after the command is received.

Command	RW
Command example	$RW^{C_{R^L} F}$
Response example	ST,GS,+00123.0kg $^{C_{R^L} F}$

Gross weight data request

Outputs gross weight data immediately after the command is received.

Command	RG
Command example	$RG^{C_{R^L} F}$
Response example	ST,GS,+00123.0kg $^{C_{R^L} F}$

Net weight data request

Outputs net weight data immediately after the command is received.

Command	RN
Command example	$RN^{C_{R^L} F}$
Response example	ST,NT,+00123.0kg $^{C_{R^L} F}$

Tare weight data request

Outputs tare weight data immediately after the command is received.

Command	RT
Command example	$RT^{C_{R^L} F}$
Response example	ST,TR,+00123.0kg $^{C_{R^L} F}$

Center zero point confirmation

Outputs whether or not it is within the center zero point.

Command	RZ
Command example	$RZ^{C_{R^L} F}$
Response example	1) $RZ,0^{C_{R^L} F}$: When it is not within the zero point 2) $RZ,1^{C_{R^L} F}$: When it is within the zero point

9.2.8.2 Control commands

Zero operation

Performs a zero operation.

Command	MZ
Command example	$MZ^{C_{R^L} F}$
Response example	$MZ^{C_{R^L} F}$

Zero clear

The zero and tare values are cleared and the gross weight is displayed.

Command	CZ
Command example	$CZ^{C_{R^L} F}$
Response example	$CZ^{C_{R^L} F}$

Tare

Subtract tare.

Command	MT
Command example	MT ^C _R ^L _F
Response example	MT ^C _R ^L _F

Tare clear

The tare is cleared, the tare value becomes zero, and the gross weight is displayed.

Command	CT
Command example	CT ^C _R ^L _F
Response example	CT ^C _R ^L _F

Gross weight display

Change the display to gross weight.

Command	MG
Command example	MG ^C _R ^L _F
Response example	MG ^C _R ^L _F

Net weight display

Change the display to net weight.

Command	MN
Command example	MN ^C _R ^L _F
Response example	MN ^C _R ^L _F

Disable key switch

Disable key switch operations.

(The disabled state induced by this command is released by turning off the power.)

Command	DK
Command example	DK ^C _R ^L _F
Response example	DK ^C _R ^L _F

Release key switch disabled state

Re-enable key switch operation through DK commands.

Command	EK
Command example	EK ^C _R ^L _F
Response example	EK ^C _R ^L _F

9.2.8.3 Commands related to holds

Begin hold

Starts a hold.

For averaging holds, either averaging standby or averaging is initiated.

The response depends on what state is currently selected.

Command	HS
Command example	HS ^C _R ^L _F
Response example	

- | | |
|-----------------------|---|
| 1) $HS_{R F}^{C L}$ | The standard state. (Neither holds nor Averaging are taking place.) |
| 2) $HD,1_{R F}^{C L}$ | During a busy state. (Averaging standby, Averaging state) |
| 3) $HD,2_{R F}^{C L}$ | During a hold state. |
| 4) $HD,3_{R F}^{C L}$ | During a simultaneous hold state and busy state. |

Release hold

Cancels a hold. At this time, averaging is canceled if it has started, and the device returns to the standard state.

Command	HC
Command example	$HC_{R F}^{C L}$
Response example	$HC_{R F}^{C L}$

Confirm hold state

Outputs hold state. (Averaging, holding, standard)

Command	HD
Command example	$HD_{R F}^{C L}$
Response example	

- | | |
|-----------------------|--|
| 1) $HD,0_{R F}^{C L}$ | During standard state. (Neither holds nor Averaging are taking place.) |
| 2) $HD,1_{R F}^{C L}$ | During Averaging. |
| 3) $HD,2_{R F}^{C L}$ | During hold. |
| 4) $HD,3_{R F}^{C L}$ | During simultaneous hold state and Averaging state. |

9.2.8.4. Commands related to near-zero detection

Read near-zero setting

Reads the set value for near-zero.

Command	RZB
Command example	$RZB_{R F}^{C L}$
Response example	$RZB,+012345_{R F}^{C L}$ (Polarity, 6 digits, no decimal point)

Write near-zero value

Sets the near-zero value.

Command	WZB, setting value
Command example	$WZB,+012345_{R F}^{C L}$
Response example	$WZB,+012345_{R F}^{C L}$ (Polarity, 6 digits, no decimal point)

9.2.8.5. Commands related to upper/lower limit settings

Read upper limit value

Reads upper limit value.

Command	RH
Command example	$RH_{R F}^{C L}$
Response example	$RH,+012345_{R F}^{C L}$ (Polarity, 6 digits, no decimal point)

Write upper limit value

Sets the upper limit value.

Command WH, setting value

Command example WH,+012345^{C_RL_F}

Response example WH,+012345^{C_RL_F}
(Polarity, 6 digits, no decimal point)

Read lower limit value

Reads lower limit value.

Command RL

Command example RL^{C_RL_F}

Response example RL,+012345^{C_RL_F}
(Polarity, 6 digits, no decimal point)

Write lower limit value

Sets the lower limit value.

Command WL, setting value

Command example WL,+012345^{C_RL_F}

Response example WL,+012345^{C_RL_F}
(Polarity, 6 digits, no decimal point)

9.2.8.6. Commands related to control I/O

Change user output

Sets user output state with a numerical value.

Returns the new user output/input states using a numerical value.

Command IOU

Command example IOU,4^{C_RL_F}

Response example IOU,40^{C_RL_F}

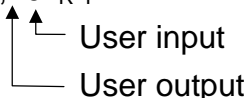

Confirm user I/O state

Returns the user output/input states using a numerical value.

Command IOU

Command example IOU^{C_RL_F}

Response example IOU,32^{C_RL_F}

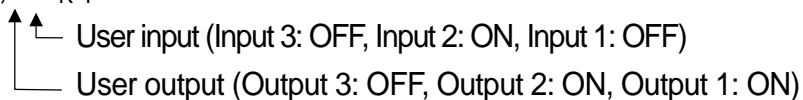

User output

Numerical value	Output 3	Output 2	Output 1
0	OFF	OFF	OFF
1	OFF	OFF	ON
2	OFF	ON	OFF
3	OFF	ON	ON
4	ON	OFF	OFF
5	ON	OFF	ON
6	ON	ON	OFF
7	ON	ON	ON

User input

Numerical value	Input 3	Input 2	Input 1
0	OFF	OFF	OFF
1	OFF	OFF	ON
2	OFF	ON	OFF
3	OFF	ON	ON
4	ON	OFF	OFF
5	ON	OFF	ON
6	ON	ON	OFF
7	ON	ON	ON

9.2.8.7. Response when the command is an error

?: Format error

V: Value error

I: Mode error

9.2.9 Modbus-RTU

Outline

When using Modbus RTU interface installed in the AD-4410, the master device can read measurement value and status information and store parameters to the AD-4410. The interface can be connected easily to computer, PLC (Sequencer) and programmable display adapted to the Modbus RTU. The built-in RS-232C (Standard), option RS-232C (OP-04) and RS-485 (OP-03) can be used for the interface and protocols. The interface can be used as slave device of Modbus RTU when presetting the function parameters of the AD-4410.

Preset Condition Of Functions

Function No.	Item	Description
<i>r5 1F01, r52F01</i>	Output data	Arbitrary selection unrelated to Modbus RTU
<i>r5 1F02, r52F02</i>	Data transfer mode	Set to 6 : Modbus RTU
<i>r5 1F03, r52F03</i>	Baud rate	Preset a number between 1 and 7 to adapt to connected device. 1 : 600 bps 2 : 1200 bps 3 : 2400 bps 4 : 4800 bps 5 : 9600 bps 6 : 19200 bps 7 : 38400 bps
<i>r5 1F04, r52F04</i>	Number of data bits, parity	0 : data 8bit, no parity is selected automatically.
<i>r5 1F05, r52F05</i>	Terminator	Arbitrary selection unrelated to Modbus RTU
<i>r5 1F06, r52F06</i>	ID number	Set a number except 0.
<i>r5 1F07, r52F07</i>	Decimal point / Delimiter	Arbitrary selection unrelated to Modbus RTU
<i>r5 1F08, r52F08</i>	Time out	Arbitrary selection unrelated to Modbus RTU
<i>r5 1F09, r52F09</i>	Delay when outputting repeatedly	Arbitrary selection unrelated to Modbus RTU
<i>r52F 10</i>	Internal resistance terminator	Normally set to 0 (Not used). Set to 1 (used) only when using an RS-485 and this device is a network terminator device.

Stop bit becomes "1" automatically.

AD-4410 Modbus Memory MAP

Kind	Address	Item	Description
Coil 00001 to 09999 (Master ⇒ Slave)	00001	Zero	1 : Execute *1
	00002	Clear the zero value	1 : Execute *1
	00003	Tare	1 : Execute *1
	00004	Clear the tare value	1 : Execute *1
	00005	Print	1 : Execute *1
	00006	F key	1 : Execute *1
	00007	Cancel error	1 : Execute *1
	00008		
	00009	Net / Gross display	1 : Net 0 : Gross
	00010	Hold	1 : Start 0 : Stop
	00011	Key inhibition	1 : Inhibition 0 : Permission
	00012	User output 1	1 : ON 0 : OFF
	00013	User output 2	1 : ON 0 : OFF
	00014	User output 3	1 : ON 0 : OFF
	00015		
	00016		

*1 After the execution, 0 is set automatically.

Kind	Address	Item	Description
Input Status 10001 to 19999 (Slave ⇒ Master)	10001	Stable	Bit 0
	10002	Net center of zero	Bit 1
	10003	Gross center of zero	Bit 2
	10004	Net display	Bit 3
	10005	Gross display	Bit 4
	10006	Tare in progress	Bit 5
	10007	Hold in progress	Bit 6
	10008	Hold busy	Bit 7
	10009	Zero tracking	Bit 8
	10010	In sync with □	Bit 9
	10011	In weighing (ON)	Bit 10
	10012	Capacity exceeded	Bit 11
	10013	Weighing failure	Bit 12
	10014	Alarm	Bit 13
	10015		Bit 14
	10016		Bit 15
	10017	Zero band	Bit 0
	10018	HI output	Bit 1
	10019	OK output	Bit 2
	10020	LO output	Bit 3
	10021	User input 1	Bit 4
	10022	User input 2	Bit 5
	10023	User input 3	Bit 6
	10024		Bit 7
	10025	User output 1	Bit 8
	10026	User output 2	Bit 9
	10027	User output 3	Bit 10
	10028		Bit 11
	10029		Bit 12
	10030		Bit 13
	10031		Bit 14
	10032		Bit 15

"Status 1" of Input Register

"Status 2" of Input Register

Kind	Address	Item	Description
	10033	Net over	Bit 0
	10034	Net under	Bit 1
	10035	Gross over	Bit 2
	10036	Gross under	Bit 3
	10037	Input (A/D) over	Bit 4
	10038	Input (A/D) under	Bit 5
	10039	Zero error	Bit 6
	10040	Tare error	Bit 7
	10041	Net display error	Bit 8
	10042		Bit 9
	10043		Bit 10
	10044	Checksum error	Bit 11
	10045	A/D error	Bit 12
	10046	FRAM error	Bit 13
	10047	Calibration error	Bit 14
	10048	Mode error	Bit 15

} "Status 3" of Input Register

Kind	Address	Item	Description
Input Register 30001 to 39999 (Slave → Master)	30001	Unit	1 : g, 2 : kg, 3 : t, 4 : N, 5 : kN (6 : lb, 7 : oz) U.S.A. version Linkage with $[ALF01]$.
	30002	Decimal point	The n-th digit from right. n : 0 to 5 Linkage with $[ALF02]$.
	30003	Tare	Low order word*1
	30004	Tare	High order word
	30005	Gross	Low order word*1
	30006	Gross	High order word
	30007	Net	Low order word*1
	30008	Net	High order word
	30009	Status 1 *2	Data of "Input Status" of Address10001 to 10016
	30010	Status 2 *2	Data of "Input Status" of Address10017 to 10032
	30011	Status 3 *2	Data of "Input Status" of Address10033 to 10048
Holding Register 40001 to 49999 (Master → Slave)	40001	Zero band	Low order word*1
	40002	Zero band	High order word
	40003	Upper limit	Low order word*1
	40004	Upper limit	High order word
	40005	Lower limit	Low order word*1
	40006	Lower limit	High order word

*1 Store the low order word of the required 2 word for tare, gross and net.

*2 The "Status 1" of the input register can store these input status bits between Address10001 and 10016.
The "Status 1" of the input register can store these input status bits between Address10017 and 10032.
The "Status 1" of the input register can store these input status bits between Address10033 and 10048.



10. Maintenance

10.1. Error Messages

If an error message is displayed, refer to the chart below to take proper measures.

Error message	Cause	Remedy
$\llbracket S \rrbracket Err$	Program checksum error	Repair is required.
$\llbracket Ad \rrbracket Err$	Data can not be acquired from the A/D converter.	Repair is required.
$\llbracket rA \rrbracket Err$	Data can not be written into the backup memory.	Repair is required.
$\llbracket FrAErr \rrbracket$	Correct data can not be read from the FRAM.	Perform initialization. If initialization does not clear the error, repair is required.
$\llbracket CALErr \rrbracket$	Calibration data is not correct.	Perform calibration.
$\llbracket ErrX \rrbracket$	Calibration error	Refer to "7.8. Calibration Errors".
$Err dt$	The setting value is out of the settable range.	Check the setting value and set again.

10.2. Check Mode

The check mode checks the performance of the display, key switches and external I/O.

10.2.1. Entering the check mode

Step 1 While pressing and holding the ENTER key, press the F key.

$\llbracket FnC \rrbracket$ is displayed to indicate that the indicator will enter the general function mode.

To go back to the weighing mode, press the ESC key.

Step 2 While pressing and holding the ZERO key, press the ENTER key.

$\llbracket hc \rrbracket$ is displayed to indicate that the indicator will enter the check mode.

Press the ENTER key again to display an item to be checked.

Step 3 Press the $\llbracket \wedge \rrbracket$ or $\llbracket \vee \rrbracket$ key to select the item to be checked and press the ENTER key to enter the check mode of the selected item.

To exit from the current mode, press the ESC key.

Display	Checking item
[hcPEY	Key switches
[hc LL	Standard serial output
[hcr51	RS-232C
[hcr52	RS-232C/485 (Option)
[hc io	Control I/O
[hc Ad	A/D (Load cell)
[hc in	Internal count
[hcPr9	Program version
[hc Sn	Serial number
[S Pr9	Program checksum
[S FrA	Memory (FRAM) checksum
[ALFdt	Calibration-related functions

10.2.2. Checking the key switches

With [hcPEY displayed, press the ENTER key to enter the key switch check mode. In the key switch check mode, six squares (□) are displayed. Each square corresponds to a key switch as shown below.

When a key switch is pressed, the corresponding square moves up (□).

When the CAL key is pressed, the minus LED turns ON.

To exit from the key switch check mode, press the ESC key twice.

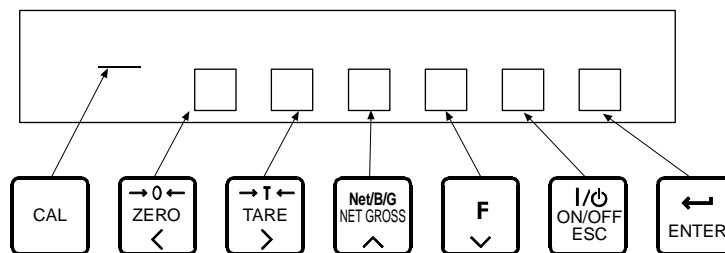

10.2.3. Checking the standard serial output

With [hc LL displayed, each time the ENTER key is pressed, the test data is transmitted with the baud rate set in the general functions and the decimal point blinks.

Test data S T , G S , + 0 0 0 0 0 . 0 k g ^CR L_F

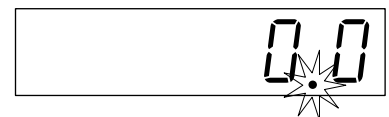

10.2.4. Checking the RS-232C

While $[hcr51]$ is displayed, each time the ENTER key is pressed, test data is transmitted using the baud rate set in general functions.

When the data is received, it is displayed for two seconds.

Test data $S T , G S , + 0 0 0 0 0 . 0 k g$ $C_R L_F$

10.2.5. Checking the RS-232C / RS-485 (Option)

While $[hcr52]$ is displayed, each time the ENTER key is pressed, test data is transmitted using the baud rate set in general functions.

When the data is received, it is displayed for two seconds.

Test data $S T , G S , + 0 0 0 0 0 . 0 k g$ $C_R L_F$

10.2.6. Checking the control I/O

While $[hc id]$ is displayed, press the ENTER key to enter control I/O mode. In control I/O mode, the control I/O state is displayed as ON (\square) or OFF (\square) on the display.

Pressing the $TARE$, F or $ENTER$ key will return the state of output 1, output 2 or output 3, respectively.

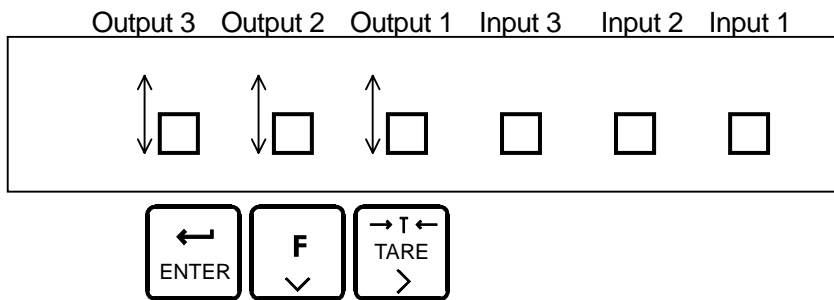

10.2.7. Checking the A/D (load cell)

With $[hc Ad]$ displayed, press the ENTER key to enter the A/D check mode. The load cell output value is displayed in mV/V.

The example below is for an internal count of 1.23456 mV/V.

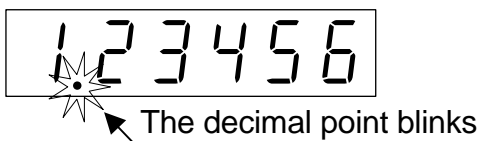

If the value exceeds rated output of the load cell, it may be because of mechanical damage or a connection error involving the load cell. Refer to “10.4. Confirming the load cell connection with a digital multi meter” to check the connection.

10.2.8. Checking the internal count

With $[hc in]$ displayed, press the ENTER key to enter the internal count check mode. The internal count value (display value times 10) is displayed.

The example below is for an internal count of 123.

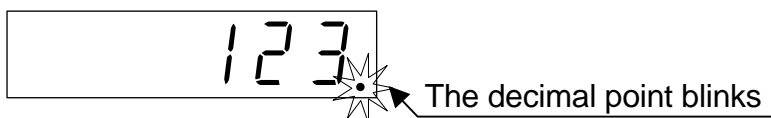

10.2.9. Checking the program version

With `[hcPr9]` displayed, press the ENTER key to display the version of the current program. The example below is for program version 1.00.

A rectangular LCD display showing the letter 'P' on the left and the number '1.00' on the right.

10.2.10. Checking the serial number

With `[hc Sn]` displayed, press the ENTER key to display the last five digits of the serial number. The example below is when the last five digits of the serial number are 12345.

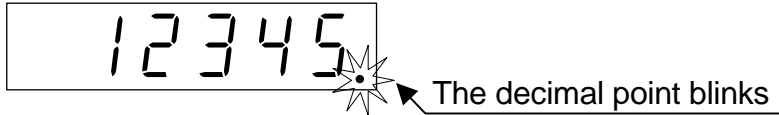
A rectangular LCD display showing the number '12345.' with a decimal point. A starburst icon points to the decimal point, and a line with an arrow points to the text 'The decimal point blinks'.

10.2.11. Checking the program checksum

With `[5 Pr9]` displayed, press the ENTER key to display the program checksum. The example below is when the checksum is EF.

A rectangular LCD display showing the number '5' on the left and the letters 'EF' on the right.

10.2.12. Checking the FRAM checksum

With `[5 FrA]` displayed, press the ENTER key to display the FRAM checksum. The memory set in the general functions is not counted. The example below is when the checksum is EF.

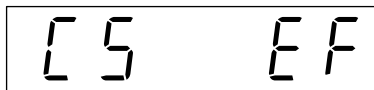
A rectangular LCD display showing the number '5' on the left and the letters 'EF' on the right.

10.2.13. Checking the calibration-related functions

With `[ALFdE]` displayed, press the ENTER key to display the settings of the calibration-related functions.

NOTE: For contents and operation of the calibration-related functions, refer to “7.6. Calibration-Related Functions”.
The settings can not be changed here.

10.3. Initialization Mode

Initialization restores the contents of the FRAM to the default values.

Three types of initialization are available as shown below.

Initialization mode	Display	Description
RAM initialization	<i>in i rA</i>	Initializes the contents of the RAM only. The zero and tare values will be restored to 0.
General functions initialization	<i>in iFnC</i>	Initializes the contents of the general functions stored in the FRAM.
All data initialization	<i>in iALL</i>	Initializes all the contents in the FRAM. The calibration-related data is also initialized. So, calibration is required before using the indicator again.

10.3.1. RAM initialization / General functions initialization

Step 1 While pressing and holding the ENTER key, press the F key.

FnC is displayed to indicate that the indicator will enter the general function mode.

To go back to the weighing mode, press the ESC key.

Step 2 While pressing and holding the ZERO key, press the ENTER key.

[hc is displayed to indicate that the indicator will enter the check mode.

Step 3 Press the ▲ or ▼ key to select the initialization mode (in i) and press the ENTER key.

Step 4 Press the ▲ or ▼ key to select the item to be initialized and press the ENTER key.

Step 5 All the status LEDs blink to prompt a confirmation. To initialize, press and hold the ENTER key for three seconds or more.

After initialization, the indicator is reset and all the display segments are ON. And the indicator enters the weighing mode.

To exit from this mode without performing initialization, press the ESC key.

10.3.2. All data initialization

Step 1 Remove the CAL key cover and press the CAL key.

`CAL` is displayed to indicate that the indicator enters the calibration mode.

Step 2 Press the ENTER key to display `CALSET`. The indicator enters the mode of calibration with an actual load. To go back to the weighing mode, press the ESC key.

Step 3 Press the `▲` or `▼` key to select the all data initialization mode (`in iALL`) and press the ENTER key.

Step 4 All the status LEDs blink to prompt a confirmation. To initialize, press and hold the ENTER key for three seconds or more.

After initialization, the indicator is reset and all the display segments are ON. The indicator then enters the weighing mode.

To exit from this mode without performing initialization, press the ESC key.

10.4. Confirming the load cell connection with a digital multi meter

The load cell connection can be checked easily using a digital multimeter.

Figure 14 shows points to confirm the load cell connection.

When a summing box is used, the same measurement must be performed, even internally.

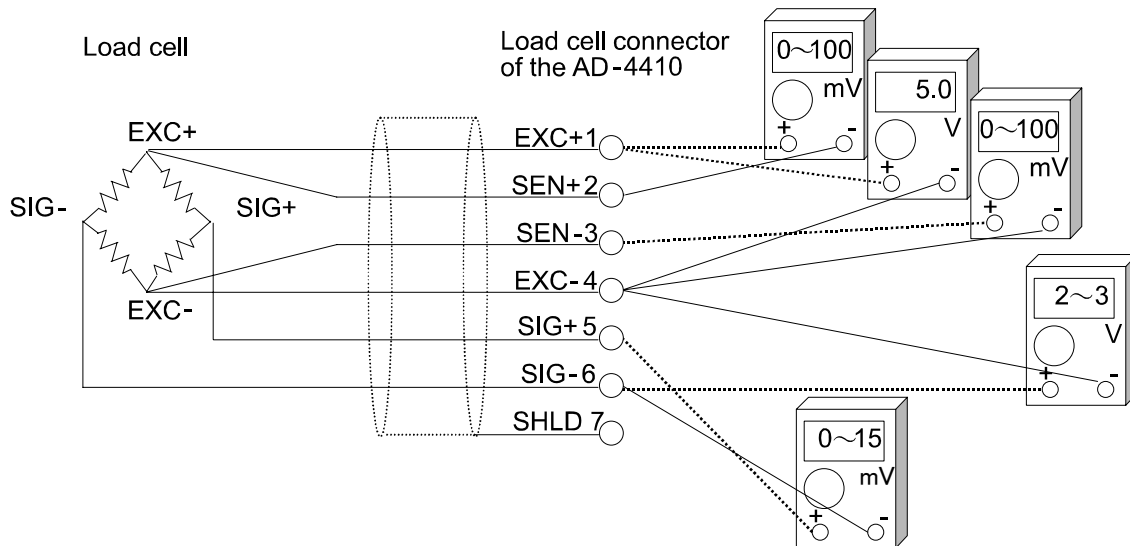

Fig.14 Method to confirm the load cell connection

Items to be measured during confirmation of the load cell connection

Measurement point	Item to be measured	Judging the voltage	
EXC+ ①	SEN+ ②	Decrease in voltage on the EXC+ side of the load cell cable	Normally 100mV or less. However, it may exceed 1V when an extremely long load cell cable is used. For the 4-wire configuration, it must be 0V.
EXC+ ①	EXC- ④	Load cell excitation voltage	If it is between 4.75 to 5.25V, it is normal.
SEN- ③	EXC- ④	Decrease in voltage on the EXC- side of the load cell cable	Normally 100mV or less. However, it may exceed 1V when an extremely long load cell cable is used. For the 4-wire configuration, it must be 0V.
SIG- ⑥	EXC- ④	Center point voltage of the load cell	Should be about 2.5 V, approximately half of excitation voltage.
SIG+ ⑤	SIG- ⑥	Output voltage of the load cell	Compare with theoretical values obtained from the load cell rated capacit, actual load and excitation voltage. Generally within 0 to 15mV.

When the AD-4410 does not operate properly, write the required items in the table below and contact your local A&D dealer.

Item	User's usage circumstances Model number, rated, measurement value etc.	Description
Load cell connection method	<input type="checkbox"/> 4-wire configuration <input type="checkbox"/> 6-wire configuration	When using the 4-wire configuration, it is necessary to connect a jumper between EXC+ and SEN+, and between EXC- and SIG-.
Model number of load cell used		
Rated capacity of the load cell	[Unit]	
Rated output of the load cell	[mV/V]	
Allowable overload of the load cell	[%]	
Number of load cells used		
Use of summing box		
Length of the extension cable	[m]	Length from the indicator to the summing box etc.
Initial load on the weighing instrument	[Unit]	
Minimum division of the weighing instrument	[Unit]	Write all digits including decimal figures. Example: 0.002kg
Weighing capacity of the weighing instrument	[Unit]	Write all digits including decimal figures. Example: 10.000kg
Load cell output during initial load (when no load is applied)	[mV/V]	From -0.1mV/V to rated sensitivity value (With the first load)
Load cell output when loaded to capacity (Or when a mass of choice is loaded)	Load cell output at Load [Units] [mV/V]	When loaded to capacity, the output value of the initial load + the rated output value of the load cell. (Must be within allowable overload)

Measurement point		Measurement contents	Measurement result
EXC+ ①	SEN+ ②	Decrease in voltage on the EXC+ side of the load cell cable	[mV]
EXC+ ①	EXC- ④	Load cell excitation voltage	[V]
SEN- ③	EXC- ④	Decrease in voltage on the EXC- side of the load cell cable	[mV]
SIG- ⑥	EXC- ④	Load cell center point voltage	[V]
SIG+ ⑤	SIG- ⑥	Load cell output voltage	[mV]



11. Setting List

When performing maintenance, use the following list as a memorandum.

When making inquiries about the product, inform your local A&D dealer of the user settings.

11.1. Basic Functions

Function No. Parameter or Setting range	Description	Default value	User setting
<i>FncF01</i> 000000 to 111111	Disables key switch 0: Does not disable the key switch function. 1: Disables the key switch function.	000000 (binary)	
<i>FncF02</i> 0 to 6	Assigns a function to the F key. 0: None 1: Manual print command 2: Hold 3: Alternate switch 4: Momentary switch 5: Clear the tare weight 6: Clear the zero value	0	
<i>FncF03</i> 1 to 3	Displays update rate 1: 20 times/second 2: 10 times/second 3: 5 times/second	1	
<i>FncF04</i> 0 to 13	Assigns a function to the □ display. 0: None 1: Zero tracking in progress 2: Alarm (Zero range setting error, over) 3: F key status 4: Near zero 5: HI output (Over upper limit value) 6: OK output (Within upper and lower limit values) 7: LO output (Under lower limit value) 8: User input 1 9: User input 2 10: User input 3 11: User output 1 12: User output 2 13: User output 3	0	

$F_{nc}F05$ 0 to 16	Digital filter (cutoff frequency) 0: None 1: 11.0 Hz 2: 8.0 Hz 3: 5.6 Hz 4: 4.0 Hz 5: 2.8 Hz 6: 2.0 Hz 7: 1.4 Hz 8: 1.0 Hz 9: 0.7 Hz 10: 0.5 Hz 11: 0.33 Hz 12: 0.25 Hz 13: 0.17 Hz 14: 0.13 Hz 15: 0.10 Hz 16: 0.07 Hz	8	
$F_{nc}F07$ 1 to 3	Hold 1: Normal hold 2: Peak hold 3: Averaging hold	1	
$F_{nc}F08$ -999999 to 999999	Near-zero value The decimal point position depends on the $[CALF02]$.	10	
$F_{nc}F09$ 1 to 2	Weight compared with near-zero 1: Gross weight 2: Net weight	1	
$F_{nc}F10$ -999999 to 999999	Upper limit value The decimal point position depends on the $[CALF02]$.	10	
$F_{nc}F11$ -999999 to 999999	Lower limit value The decimal point position depends on the $[CALF02]$.	- 10	
$F_{nc}F12$ 1 to 2	Weight compared with upper and lower limits 1: Gross weight 2: Net weight	1	
$F_{nc}F13$ 1 to 2	Output logic of the upper and lower limits 1: Positive logic 2: Negative logic	1	

11.2. Hold

Function No. Parameter or Setting range	Description	Default value	User setting
<i>HLdF01</i> 0.00 to 9.99	Averaging time Units in seconds. Averaging is not done for 0.00.	0.00	
<i>HLdF02</i> 0.00 to 9.99	Start wait time Units in seconds.	0.00	
<i>HLdF03</i> 0 to 2	Automatic start conditions 0: Do not use automatic start. 1: Above near-zero range and stable 2: Above near-zero range	0	
<i>HLdF04</i> 0 to 1	Release when control input falls 0: Do not release 1: Release	1	
<i>HLdF05</i> 0.00 to 9.99	Release after time limit Units in seconds. 0.00 will not cause a release.	0.00	
<i>HLdF06</i> 0 to 999999	Release due to fluctuation The decimal point position depends on [ALF02]. 0 does not cause a release.	0	
<i>HLdF07</i> 0 to 1	Release within near-zero range 0: Cancellation has no function 1: Cancellation has function	0	

11.3. Control I/O

Function No. Parameter or Setting range	Function	Description	Default value	User setting
<i>.0 F01</i> 0 to 13	Control input 1	0: None 1: Zero 2: Zero clear 3: Tare 4: Tare clear	1	
<i>.0 F02</i> 0 to 13	Control input 2	5: Gross weight display 6: Net weight display 7: Changing between gross weight or net weight 8: Hold	3	
<i>.0 F03</i> 0 to 13	Control input 3	9: Print command 10: <input type="button" value="F"/> key 11: User input 1 12: User input 2 13: User input 3	7	
<i>.0 F04</i> 0 to 18	Control output 1	0: None 1: Stabilization 2: While displaying gross weight 3: While displaying net weight 4: During tare 5: Near zero 6: During hold	3	
<i>.0 F05</i> 0 to 18	Control output 2	7: Hold busy state 8: HI output (Over upper limit) 9: OK output (Within upper and lower limits) 10: LO output (Less than lower limit)	4	
<i>.0 F06</i> 0 to 18	Control output 3	11: User output 1 12: User output 2 13: User output 3 14: While weighing (On) 15: While weighing (1 Hz) 16: While weighing (50 Hz) 17: Zero correction error 18: Tare error	5	

11.4. Standard Serial Output

Function No. Parameter or Setting range	Description	Default value	User setting
<i>[L F01 1 to 5</i>	Output data 1: Displayed weight 2: Gross weight 3: Net weight 4: Tare weight 5: Gross/Net/Tare	1	
<i>[L F02 1 to 3</i>	Data transfer mode 1: Stream 2: Auto printing 3: Manual printing	1	
<i>[L F03 1 to 2</i>	Baud rate 1: 600 bps 2: 2400 bps	2	
<i>[L F04 0 to 99</i>	ID number 0: Does not add an ID number. 1: 99:	0	

11.5. RS-232C (Standard) / RS-232C (ch2) / RS-485

Function No. Parameter or Setting range	Description	Default value	User setting
<i>rS1F01</i> <i>rS2F01</i> 1 to 5	Output data 1: Display weighing value 2: Gross weight 3: Net weight 4: Tare weight 5: Gross weight / Net weight / Tare weight	1	
<i>rS1F02</i> <i>rS2F02</i> 1 to 6	Data transfer mode 1: Stream (Every time display refreshes) 2: Auto print 3: Manual print 4: Jet stream (Every sampling) 5: Command 6: Modbus-RTU	1	
<i>rS1F03</i> <i>rS2F03</i> 1 to 7	Baud rate 1: 600bps 2: 1200bps 3: 2400bps 4: 4800bps 5: 9600bps 6: 19200bps 7: 38400bps	3	
<i>rS1F04</i> <i>rS2F04</i> 0 to 2	Number of data bits, parity 0: 8-bit data, no parity 1: 7-bit data, odd parity 2: 7-bit data, even parity	2	
<i>rS1F05</i> <i>rS2F05</i> 1 to 2	Terminator 1: CR, LF 2: CR	1	
<i>rS1F06</i> <i>rS2F06</i> 0 to 99	ID number 0: None 1 to 99	0	
<i>rS1F07</i> <i>rS2F07</i> 1 to 2	Decimal point / Delimiter 1: Decimal point: dot / Delimiter: comma 2: Decimal point: comma / Delimiter: semicolon	1	
<i>rS1F08</i> <i>rS2F08</i> 0 to 1	Time out 1: No limit 2: Approx. 1 second	1	
<i>rS1F09</i> <i>rS2F09</i> 0 to 4	Delay when outputting repeatedly 0: No delay 1: Approx. 0.5 second 2: Approx. 1.0 second 3: Approx. 1.5 second 4: Approx. 2.0 second	0	
<i>rS2F10</i> 0 to 1	Internal terminator resistance 0: None 1: Available (120Ω) Available only when RS-485 is used	0	

11.6. Linearity-Related

Function No. Parameter or Setting range	Description	Default value	User setting
<i>LnrF01</i> 0 to 5	Number of input points Linearity zero input is included in this.	0	
<i>LnrF02</i> - 700000 to 700000	Linearity zero Units in mV/V.	0.000000	
<i>LnrF03</i> 0 to 999999	Linearity 1 mass value The decimal point position depends on the <i>CALF02</i> .	0	
<i>LnrF04</i> 0.000000 to 9.99999	Linearity 1 span Units in mV/V.	0.000000	
<i>LnrF05</i> 0 to 999999	Linearity 2 mass value The decimal point position depends on the <i>CALF02</i> .	0	
<i>LnrF06</i> 0.000000 to 9.99999	Linearity 2 span Units in mV/V.	0.000000	
<i>LnrF07</i> 0 to 999999	Linearity 3 mass value The decimal point position depends on the <i>CALF02</i> .	0	
<i>LnrF08</i> 0.000000 to 9.99999	Linearity 3 span Units in mV/V.	0.000000	
<i>LnrF09</i> 0 to 999999	Linearity 4 mass value The decimal point position depends on the <i>CALF02</i> .	0	
<i>LnrF10</i> 0.000000 to 9.99999	Linearity 4 span Units in mV/V.	0.000000	

11.7. Calibration-Related

Function No. Parameter or Setting range	Description	Default value	User setting
<i>CALF01</i> 0 to 7	Unit of the weight value 0: None 1: g 2: kg 3: t 4: N 5: kN 6: lb (U.S.A. version) 7: oz (U.S.A. version)	2	
<i>CALF02</i> 0 to 5	Decimal point position of the weight value: 10 ⁿ	0	
<i>CALF03</i> 1 to 6	Minimum division (d) of the weight value 1: 1 2: 2 3: 5 4: 10 5: 20 6: 50	1	
<i>CALF04</i> 1 to 999999	Weighing capacity of the weighing instrument The decimal point position is the same as the setting of <i>CALF02</i> .	70000	
<i>CALF05</i> 0 to 100	Range to enable zero adjustment by the ZERO key Expressed in percent of the weighing capacity with the calibration zero point as the center	2	
<i>CALF06</i> 0.0 to 5.0	Zero tracking time (Unit: second) When 0.0, zero tracking will not be performed.	0.0	
<i>CALF07</i> 0.0 to 9.9	Zero tracking band (Unit: 0.1 d) When 0.0, zero tracking will not be performed.	0.0	
<i>CALF08</i> 0.0 to 9.9	Stability detection time (Unit: second) When 0.0, stability detection will not be performed.	1.0	
<i>CALF09</i> 0 to 9	Stability detection band (Unit: d) When 0, stability detection will not be performed.	2	
<i>CALF10</i> 0 to 1	Tare and zero adjustment when the weight value is unstable. 0: Disables both functions. 1: Enables both functions.	1	
<i>CALF11</i> 0 to 1	Tare when the gross weight is negative. 0: Disables tare. 1: Enables tare.	1	
<i>CALF12</i> 0 to 1	Standard serial output if the weight value overflows and is unstable. 0: Disables output. 1: Enables output.	1	

Function No. Parameter or Setting range	Description	Default value	User setting
<i>CALF 13</i> 1 to 3	To judge when the negative gross weight is exceeded. A/D negative exceeded or, 1: Gross weight < -999999 2: Gross weight < negative weighing capacity 3: Gross weight < -19 d	1	
<i>CALF 14</i> 1 to 2	To judge when the negative net weight is exceeded. Gross weight negative exceeded or, 1: Net weight < -999999 2: Net weight < negative weighing capacity	1	
<i>CALF 15</i> 0 to 1	Select whether or not to clear the zero value. 0: Disables. 1: Enables.	1	
<i>CALF 16</i> 0 to 1	Select whether or not to perform zero upon power-ON. 0: Disables. 1: Enables.	0	
<i>CALF 17</i> -700000 to 700000	Input voltage from a load cell at zero. X.XXXXX mV/V	0.00000	
<i>CALF 18</i> 0.00000 1 to 999999	Input voltage from a load cell at span X.XXXXX mV/V	3.20000	
<i>CALF 19</i> 1 to 999999	The value of the calibration weight corresponding to the span input voltage	32000	
<i>CALF 20</i> 0 to 1	Select whether or not to output when the gross weight is negative. 0: Enables output. 1: Disables output.	0	
<i>CALF 21</i> 0 to 1	Select whether or not to restrict network-related communication. 0: Disables restriction. 1: Enables restriction.	0	
<i>CALF 22</i> 1 to 2	Second header for serial output 1: GS / NT / TR 2: G_ / N_ / T_ (_ is space, ASCII 20h)	1	
<i>CALF 23</i> 1 to 2	Number of unit digits for serial output 1: 2 digits 2: 3 digits	1	
<i>CALF 24</i> 1 to 6	Scale interval of dual range 1: 1 2: 2 3: 5 4: 10	1	

	5: 20 6: 50		
CALF25 0 to 999999	Dual range border	0	
CALF26 9.75000 to 9.85000	Gravity acceleration in the location of calibration Units in m/s ² .	9.80000	
CALF27 9.75000 to 9.85000	Gravity acceleration in the location of use Units in m/s ² .	9.80000	
CALF28 0 to 1	Disabling hold 0: Enabled 1: Disabled	0	



12. External Dimensions

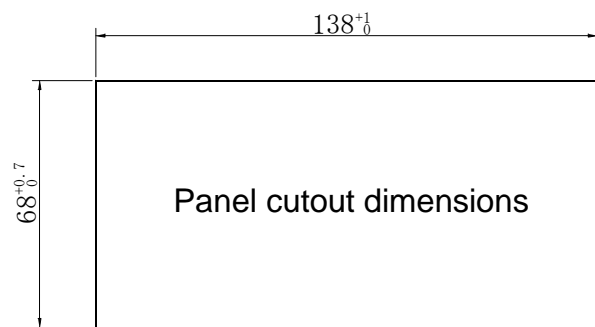
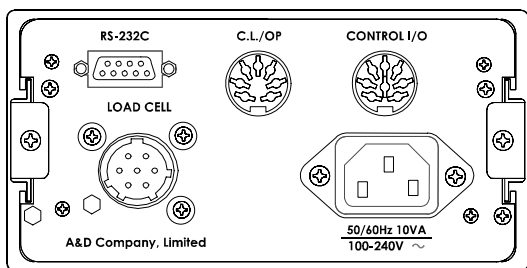
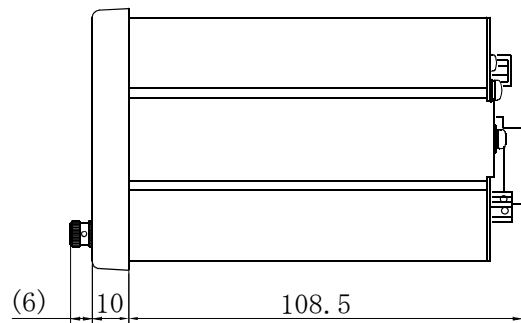
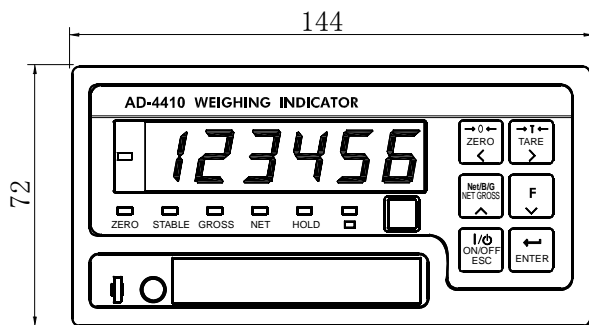

Unit: mm

Fig.15 External dimensions

When installing the AD-4410 to the optional stand (AD4410-11)

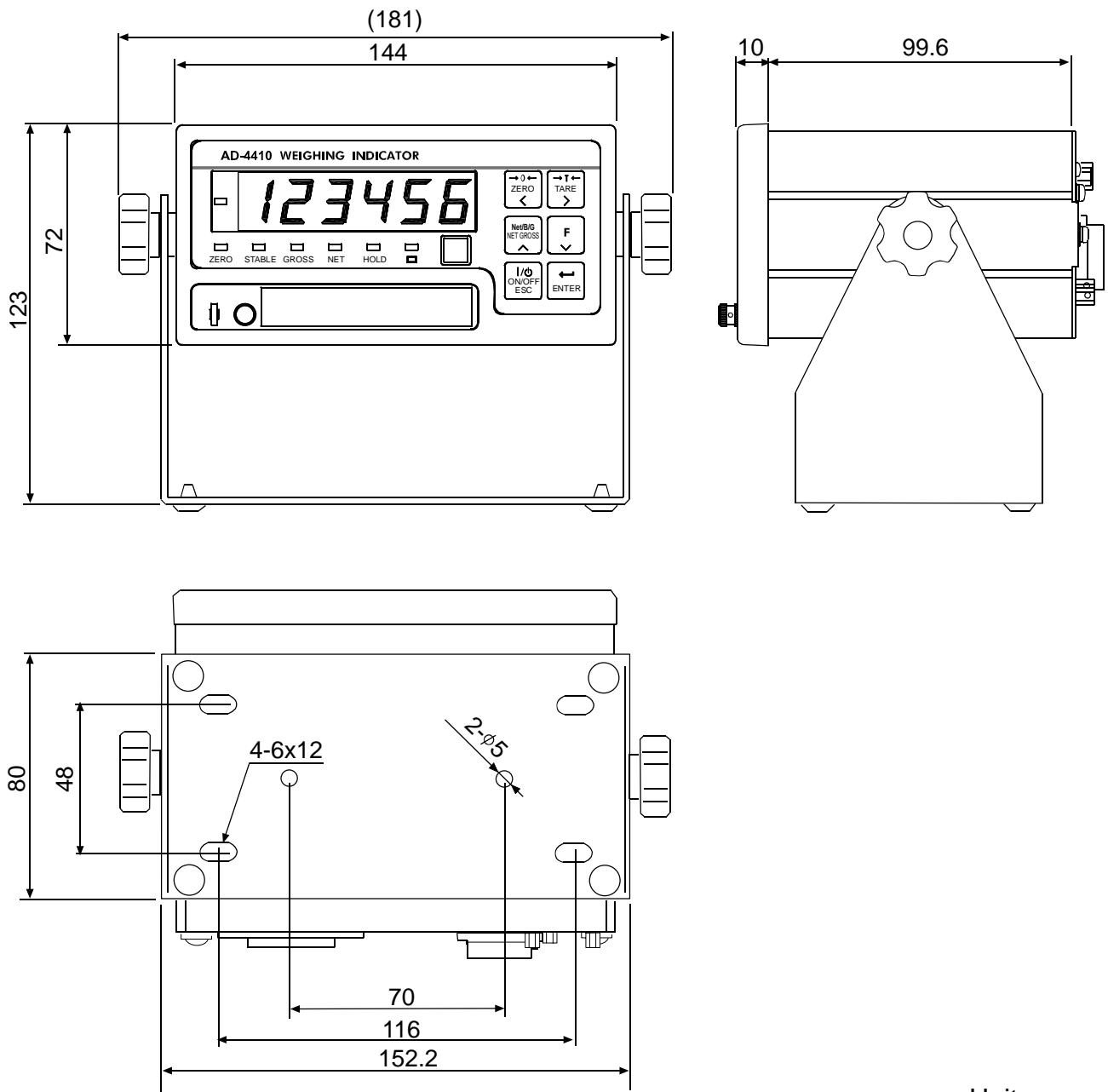

Unit: mm

Fig.16 External dimensions (when installing the AD4410-11)

